

DIY CATALOG

2022

GERMAN
HARDWARE
TECHNOLOGY

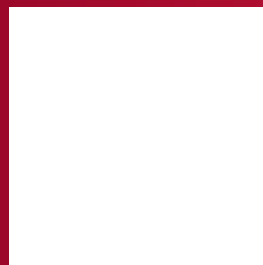



YOUR COMPLETE PROJECT PARTNER.

Häfele Philippines, Inc. has established itself as the premier supplier of German furniture fittings and architectural hardware in the Philippines since 1995. We have been supporting architects, engineers, designers and traders by providing the latest technical solutions that our international clients also avail of.

The Häfele Essentials Catalogue is a concise manual that features our best-selling items from bathroom accessories, door hardware, kitchen appliances, and cabinet fittings. This catalog covers all your building needs, be it a residential or commercial project, or a retail trade segment.

All our products have been developed with our customers in mind, which is an integral part of the world-renowned Häfele quality of service and innovation.

PLEASE CONTACT

NAME:

TELEPHONE NUMBER:

MOBILE:

EMAIL:



- Econo 4 Holes
- Slide-on
- Opening angle 105°
- Non-Softclose



Nickel Plated

Description	Cat. No.
Overlay	483.01.810
Midlay	483.01.811
Inlay	483.01.812

- Packing: 2pcs. Hinge
- 2 pcs. M. Plate
- 12 pcs. screws

- Metalla SM
- Opening angle 110°
- Cup Ø 35
- Clip-on Softclose
- For Wooden doors



Black Nickel Plated

Description	Cat. No.
Full overlay	306.00.032
Half overlay	306.00.033
Inset	306.00.034

- Packing: 2pcs. Hinge
- 2 pcs. M. Plate
- 12 pcs. screws

- Metalla matt Hinge
- Cup Ø 35
- Opening angle 110°
- 2-Hole Mounting Plate



Nickel Plated

Description	Cat. No.
Overlay	493.01.832
Midlay	493.01.833
Inlay	493.01.834

- Packing: 2pcs. Hinge
- 1 pc. M. Plate
- 8 pcs. screws

- Metalla matt Hinge
- Cup Ø 35
- Opening angle 110°
- (4-Hole Mounting Plate)



Nickel Plated

Description	Cat. No.
Overlay	493.01.829
Midlay	493.01.830
Inlay	493.01.831

- Packing: 2pcs. Hinge
- 2 pcs. M. Plate
- 12 pcs. screws

- Metalla SM
- Opening angle 110°
- SUS304
- SoftClose
- For Wooden doors



Stainless

Description	Cat. No.
Overlay	315.07.096
Midlay	315.07.097
Inlay	315.07.098

- Packing: 2pcs. Hinge
- 2 pcs. M. Plate
- 12 pcs. screws

- Metalla SM
- Clip-on Softclose
- Opening angle 110°



Nickel Plated

Description	Cat. No.
Full overlay	311.01.129

- Packing: 2pcs. Hinge
- 2 pcs. M. Plate
- 8 pcs. screws

- Metalla-SM
- Cup Ø 35
- Soft-Closing
- Opening Angle 110°

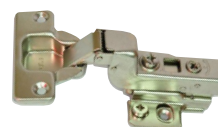

Nickel Plated

Description	Cat. No.
Overlay	483.01.580
Midlay	483.01.581
Inlay	483.01.582

- Packing: 2pcs. Hinge
- 2 pcs. M. Plate
- 10 pcs. screws

Full overlay mounting

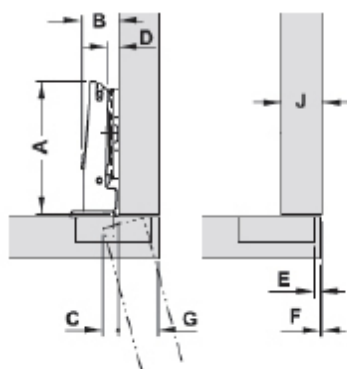

A. Hinge arm length
B. Hinge arm height
C. Door offset

Half overlay mounting/twin mounting

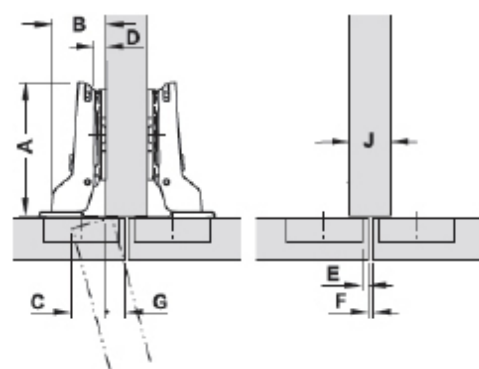

D. Distance(Mounting Plate)
E. Distance to cup
F. Gap

Inset mounting

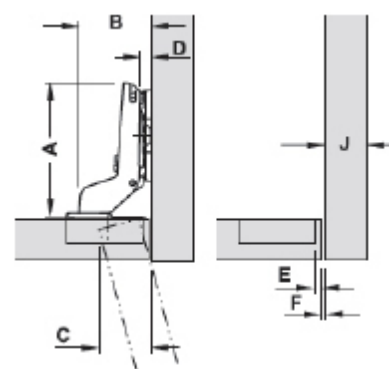

G. Door Overlay
J. Material thickness



Material: Steel
Finish: Stainless steel colored

Dimension	Cat. No.
136 x 35 mm	491.44.314
168 x 35 mm	491.44.315
200 x 35 mm	491.44.361
232 x 35 mm	491.44.316
250 x 35 mm	491.44.362
300 x 35 mm	491.44.363
328 x 35 mm	491.44.317
392 x 35 mm	491.44.318
400 x 35 mm	491.44.364
488 x 35 mm	491.44.365
500 x 35 mm	491.44.366
600 x 35 mm	491.44.319
700 x 35 mm	491.44.320



Material: Zinc alloy
Finish: Nickel matt / Wood brown

Dimension	Cat. No.
148 x 30 x 128 mm	491.44.307



Material: Zinc alloy
Finish: Stainless steel Colored

Dimension	Cat. No.
122 x 30 x 96 mm	491.44.309



Material: Zinc alloy
Finish: Black

Dimension	Cat. No.
188 x 27 x 128 mm	491.44.338



Material: Zinc alloy
Finish: Chrome plated

Dimension	Cat. No.
126 x 27 x 96 mm	491.44.300
160 x 29 x 128 mm	491.44.301



Material: Aluminum
Finish: Chrome plated

Dimension	Cat. No.
126 x 27 x 96 mm	491.44.492
160 x 29 x 128 mm	491.44.493



Material: Zinc alloy
Finish: Chrome plated

Dimension	Cat. No.
108 x 28 x 96 mm	491.44.310
140 x 28 x 128 mm	491.44.311



Material: Zinc alloy
Finish: Nickel plated matt

Dimension	Cat. No.
108 x 26 x 96 mm	491.44.312



Material: Zinc alloy
Finish: Chrome matt

Dimension	Cat. No.
160 x 128 x 29 mm	491.44.329



Material: Zinc alloy
Finish: Nickel plated matt

Dimension	Cat. No.
113 x 24 x 96 mm	491.44.306



Material: Zinc alloy
Finish: Nickel plated matt

Dimension	Cat. No.
155 x 30 x 128 mm	491.44.303



Material: Steel
Finish: Chrome polished

Dimension	Cat. No.
104mm x 35mm x 96mm	491.44.341



Material: Zinc alloy
Finish: Burnished brass

Dimension	Cat. No.
128 x 22 x 76 mm	491.44.334



Material: Zinc alloy
Finish: Chrome polished

Dimension	Cat. No.
111 x 30 x 96 mm	491.44.328



Material: Zinc alloy
Finish: Stainless steel Colored

Dimension	Cat. No.
117 x 20 x 96 mm	491.44.325



Material: Zinc alloy
Finish: Stainless steel Colored

Dimension	Cat. No.
146 x 29 x 128 mm	491.44.321



Material: Steel
Finish: Chrome polished

Dimension	Cat. No.
128 x 25 x 96 mm	491.44.322



Material: Steel
Finish: Nickel plated matt

Dimension	Cat. No.
128 x 25 x 96 mm	491.44.323



Material: Zinc alloy
Finish: Chrome polished

Dimension	Cat. No.
126 x 28 mm	491.44.304



Material: Zinc alloy
Finish: Chrome matt

Dimension	Cat. No.
126 x 28 mm	491.44.305



Material: Zinc alloy
Finish: Nickel plated matt

Dimension	Cat. No.
128 x 28 x 96 mm	491.44.324



Material: Stainless Steel 304 (Hollow)

Dimension	Cat. No.
175 x 160 x 40 mm	481.05.073



Material: Stainless Steel 304 (Hollow)

Dimension	Cat. No.
140 x 128 x 35 mm	481.05.074



Material: Stainless Steel 304

Dimension	Cat. No.
140 x 128 x 35 mm	481.05.075

Pull Handles



Material: Zinc alloy
Finish: Antique bronze

Dimension	Cat. No.
30 x 17 x 60 mm	491.44.330



Material: Zinc alloy
Finish: Antique bronze

Dimension	Cat. No.
160 x 128 x 29 mm	491.44.482



Material: Zinc alloy
Finish: Nickel plated

Dimension	Cat. No.
25 x 22 mm	491.54.703



Material: Zinc alloy
Finish: Chrome polished

Dimension	Cat. No.
25 x 22 mm	491.54.702



Material: Zinc alloy
Finish: Chrome polished

Dimension	Cat. No.
30 x 28 mm	491.54.708

Flush Handle



Finish/Dimension	Cat. No.
Satin Stainless Steel 115 x 42 mm	489.72.130
Black 115 x 42 mm	489.72.135



Stainless Steel Matt

Finish/Dimension	Cat. No.
Stainless Steel Matt 120 x 40 x 15 mm	489.72.120
Black 120 x 40 x 15 mm	489.72.124



Zinc gray

Dimension	Cat. No.
34 x 111 x 96 mm	491.44.360



Satin Stainless Steel

Dimension	Cat. No.
100 x 1.5 x 85 mm	481.05.010
180 x 1.5 x 160 mm	481.05.011



Chrome plated

Dimension	Cat. No.
Polished 40 x 42 mm	491.44.337

Profile Handle



Aluminum

Dimension	Cat. No.
2500 x 43 x 20 x 1.6 mm	491.44.500



Aluminum

Dimension	Cat. No.
2500 x 30 x 19.5 mm	491.44.501



Aluminum

Dimension	Cat. No.
2500 x 21 x 19.5 mm	481.21.920



Aluminum / Black matt

Dimension	Cat. No.
800 x 736 x 27 mm	481.21.332





Description	Cat. No.
Mag. pressure catch 1 wing black, for glass doors, pull 1.8 kg	482.02.173



Description	Cat. No.
Spring catch, Burnished, counter piece: White	482.02.239



Description	Cat. No.
Mag. pressure catch 2 wing black, for 2-leaf glass doors, pull 2.5 kg	482.02.171



Description	Cat. No.
Twin ball catch 43 mm, bright brass	482.02.265
Twin ball catch 49 mm, bright brass	482.02.266



Description	Cat. No.
Magnetic catch brown, pull 3.0-4.0 kg	482.02.177



Description	Cat. No.
Magnetic push catch grey, pull 0.5kg	483.01.902



Description	Cat. No.
Magnetic catch brown, pull 2.0 kg	482.02.104
Magnetic catch white, pull 2.0 kg	482.02.105



Description	Cat. No.
Gas-filled strut, nickel plated, Spring force 100 N	483.98.009



Description	Cat. No.
Twin roller catch, ant. copper	482.02.216



Description	Cat. No.
Lid stay, for wooden flaps, Right	365.31.600
Lid stay, for wooden flaps, Left	365.31.601



Description	Cat. No.
Double roller catch, copper	482.02.220

- Ball Bearing
- Drawer Runners
- Full Extension
- Loading capacity up to 30 kg



Push to Open

Dimension	Galvanized Cat. No.	Black Cat. No.
300 mm	494.02.081	494.02.091
350 mm	494.02.082	494.02.092
400 mm	494.02.083	494.02.093
450 mm	494.02.084	494.02.094
500 mm	494.02.085	494.02.095

Soft closing

Dimension	Galvanized Cat. No.	Black Cat. No.
300 mm	494.02.061	494.02.071
350 mm	494.02.062	494.02.072
400 mm	494.02.063	494.02.073
450 mm	494.02.064	494.02.074
500 mm	494.02.065	494.02.075

- Ball Bearing
- Drawer Guides
- Full Extension
- Black
- Loading capacity up to 30 kg



Dimension	Cat. No.
300 mm/12"	494.02.270
350 mm/14"	494.02.271
400 mm/16"	494.02.272
450 mm/18"	494.02.273
500 mm/20"	494.02.274
550 mm/22"	494.02.275
600 mm/24"	494.02.276

- Soft Roller
- Single Extension
- White
- Loading capacity up to 15 kg



Dimension	Cat. No.
250 mm/10"	494.02.560
300 mm/12"	494.02.561
350 mm/14"	494.02.562
400 mm/16"	494.02.563
450 mm/18"	494.02.564
500 mm/20"	494.02.565
550 mm/22"	494.02.566

- Soft Roller
- Single Extension
- Brown
- Loading capacity up to 15 kg



Dimension	Cat. No.
250 mm/10"	494.02.540
300 mm/12"	494.02.541
350 mm/14"	494.02.542
400 mm/16"	494.02.543
450 mm/18"	494.02.544
500 mm/20"	494.02.545

- Soft Roller
- Single Extension
- Silver



Dimension	Cat. No.
Loading Capacity 20 kg	
250 mm/10"	494.02.590
300 mm/12"	494.02.591
350 mm/14"	494.02.592
400 mm/16"	494.02.593
450 mm/18"	494.02.594
Loading Capacity 17 kg	
500 mm/20"	494.02.595
550 mm/22"	494.02.596

- Soft Roller
- Single Extension
- White
- Loading capacity up to 20 kg



Dimension	Cat. No.
250 mm/10"	494.02.570
300 mm/12"	494.02.571
350 mm/14"	494.02.572
400 mm/16"	494.02.573
450 mm/18"	494.02.574
500 mm/20"	494.02.575
550 mm/22"	494.02.576

- Soft Roller
- Single Extension
- Brown
- Loading capacity up to 20 kg



Dimension	Cat. No.
250 mm/10"	494.02.550
300 mm/12"	494.02.551
350 mm/14"	494.02.552
400 mm/16"	494.02.553
450 mm/18"	494.02.554
500 mm/20"	494.02.555

- Full extension
- Loading capacity up to 30 kg
- Soft Closing



19 mm side panel

Dimension	Cat. No.
350 mm	433.10.535
400 mm	433.10.540
450 mm	433.10.545
500 mm	433.10.550

16 mm side panel

Dimension	Cat. No.
300 mm	433.10.430
350 mm	433.10.435
400 mm	433.10.440
450 mm	433.10.445
500 mm	433.10.450

- Full extension
- Loading capacity up to 30 kg
- Push to Open



Dimension	Cat. No.
300 mm	421.26.031
350 mm	421.26.032
400 mm	421.26.033
450 mm	421.26.034
500 mm	421.26.035

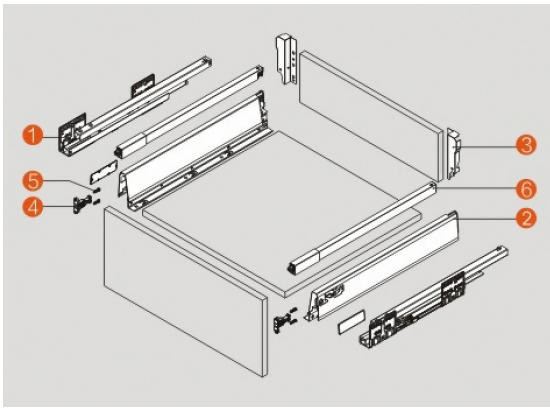

1. Drawer Runners L / R
2. Drawer Sides L / R
3. Rear Connecting Brackets L / R
4. Front Fixing Bracket, screw fixing
5. Side Cover Cap
6. Standard Gallery Rails

Drilling dimensions:

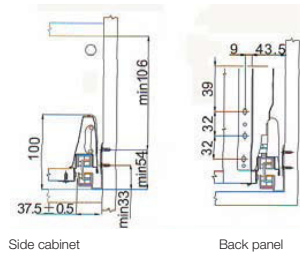

1. This drilling hole can be used when the slides are at closed position
2. This drilling hole can be used when the slides are pull-out

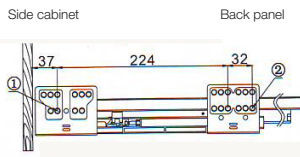

Drawer Set 84 mm



- Material: Steel
- Finish: Drawer side: Ral 7088 Grey
- Description: Full extension, soft closing and self closing mechanism

- Runner type B
- Load bearing capacity: 35 kg
 - Front fixing: Screw fixing
 - Adjustment facility: Integrated 3D front adjustment

Drawer width	Internal Drawer	Cat. No.
450 mm	424 mm	552.66.544
500 mm	474 mm	552.66.545



Drawer Set 135 mm



- Material: Steel
- Finish: Drawer side: Ral 7088 Grey
- Description: Full extension, soft closing and self closing mechanism

- Runner type B
- Load bearing capacity: 35 kg
 - Front fixing: Screw fixing
 - Adjustment facility: Integrated 3D front adjustment



Drawer width	Internal Drawer	Cat. No.
450 mm	424 mm	552.77.534
500 mm	474 mm	552.77.535

Drawer Set 199 mm



- Material: Steel
- Finish: Drawer side: Ral 7088 Grey
- Description: Full extension, soft closing and self closing mechanism

- Runner type B
- Load bearing capacity: 35 kg
 - Front fixing: Screw fixing
 - Adjustment facility: Integrated 3D front adjustment

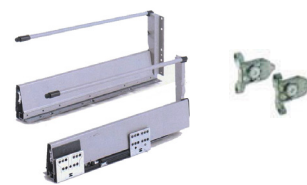

Drawer width	Internal Drawer	Cat. No.
450 mm	424 mm	552.75.534
500 mm	474 mm	552.75.535

- Packing: 1 Set
- Mid gallery rails are optional. Please order separately.



Dimension	Cat. No.
450 mm	552.70.554
500 mm	552.70.555

Internal front panel / rail and holder



Front panel set	Cat. No.
Drawer front for 84 / 1200 mm	552.62.506

Packing: 1 Set



Front panel set	Cat. No.
Drawer front for 135 / 1200 mm	552.62.526

Packing: 1 Set



Front panel set	Cat. No.
Drawer front for 199 / 1200 mm	552.62.546

Packing: 1 Set

Glass clip set



•Material: Glass , Plastic

Length	Cat. No.
500 mm	552.70.115

Packing: 1 Set

Wall side and diving panels

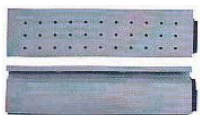

• Material: Steel, grey

Length	Cat. No.
Twin wall side panel, 450 mm	552.70.504
Twin wall side panel, 500 mm	552.70.505

Packing: 1 Pair



Length	Cat. No.
Horizontal dividing panel, 1200 mm	552.61.585
Vertical dividing panel	552.61.590

Packing: 1 Piece

Cutlery inserts



• Material: Plastic

For Cabinet width (mm)	Cat. No.
(A) 450	556.53.545
(B) 500	556.53.550
(C) 600	556.53.560

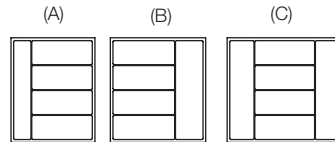

Plate carrier



• Finish: Light Grey
• Version: Adjust via press button
Hold plates from Ø180 – 350 mm

Cabinet width	Quantity needed	Cat. No.
450 - 500 mm	1 - 2 pcs	550.19.590

Packing: 1 pc.



Accept Plates	180-335 mm diameter
Plates height-max	147 mm
Rack Height overall	171 mm
Material	High Impact Plastic

Häfele Matrix Box S Drawer set
H84: Drawer side height 84 mm

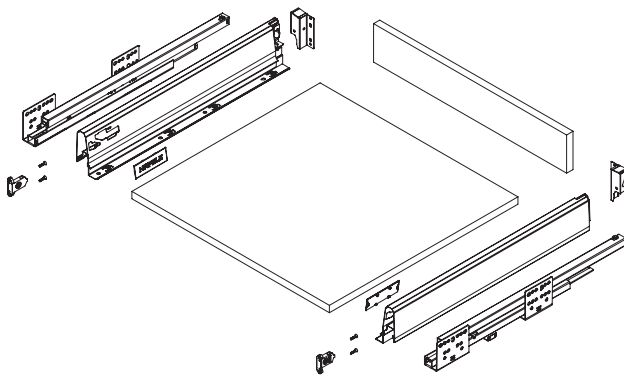

Internal installation height

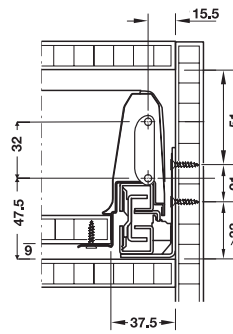

Rear panel installation dimensions

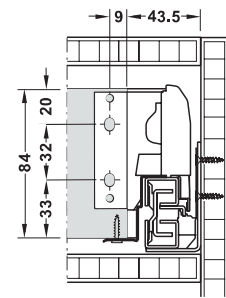

- Material: Steel
- Finish: Drawer sides: Powder coated, grey
Cabinet runner: Galvanized
- Load bearing capacity: 35 kg
- Type of pull-out: Full extension, with integrated soft closing mechanism

Depth (mm)	Cat. No.
450	552.56.694
500	552.56.695

Packing: 1 set

Supplied with

- 1 left and 1 right drawer side
- 1 left and 1 right cabinet runner
- 1 pair of screw on front fixing brackets
- 1 left and 1 right back panel bracket
- 1 pair of cover caps

Häfele Matrix Box S Drawer Set
H135: Drawer side height 84 mm, with rectangular railing

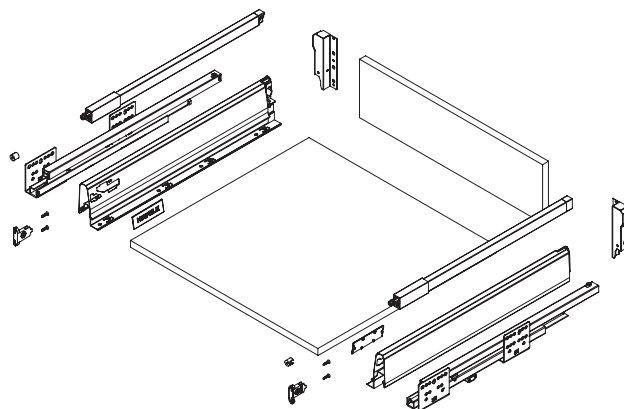

Internal installation height

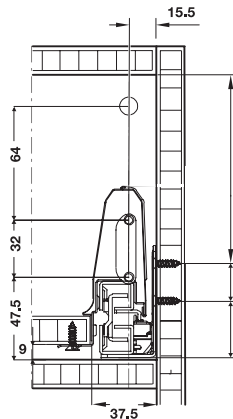

Rear panel installation dimensions

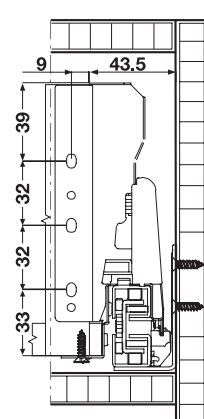

- Material: Steel
- Finish: Powder coated, grey
Cabinet runner: Galvanized
- Load bearing capacity: 35 kg
- Type of pull out: Full extension, with integrated soft closing mechanism

Depth (mm)	Cat. No.
450	552.57.694
500	552.57.695

Packing: 1 set

Supplied with

- 1 left and 1 right drawer side
- 1 left and 1 right cabinet runner
- 1 pair of screw on front fixing brackets
- 1 left and 1 right back panel bracket
- 1 pair of cover caps
- 1 set of rectangular side railings and fixings

Häfele Matrix Box S Drawer Set
H199: Drawer side height 84 mm, with rectangular railing



Internal installation height

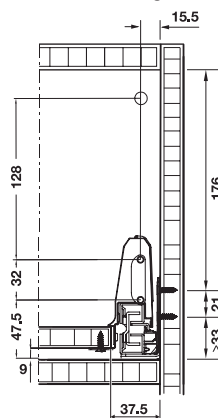

Rear panel installation dimensions

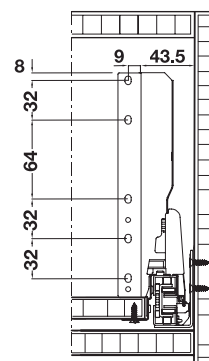

- Material: Steel
- Finish: Powder coated, grey
Galvanised
- Load bearing capacity: 35
- Type of pull out: Full extension, with integrated soft closing mechanism

Depth (mm)	Cat. No.
450	552.58.694
500	552.58.695

Packing: 1 set

Supplied with

- 1 left and 1 right drawer side
- 1 left and 1 right cabinet runner
- 1 pair of screw on front fixing brackets
- 1 left and 1 right back panel bracket
- 1 pair of cover caps
- 1 set of rectangular side railings and fixings

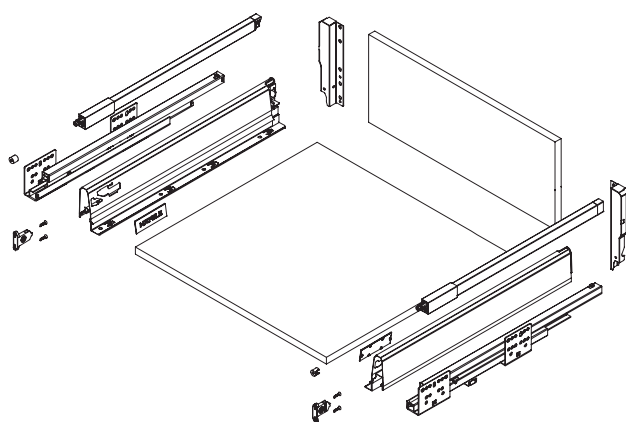

Internal drawer
Drawer side height 84 mm

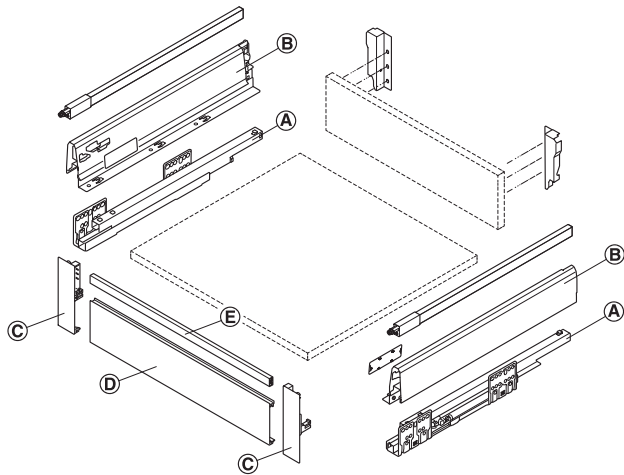

Internal drawer with rear panel height 135 mm

- A - cabinet runner
- B - double-walled drawer sides 84 mm with cover caps
- C - panel holder
- D - panel
- length = internal cabinet width – 87 mm
- E - cross rail
- length = internal cabinet width – 71 mm

Front bracket set for internal pull out C

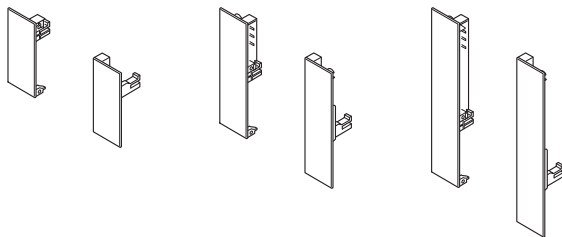

• Material: Plastic

Height (mm)	Cat. No.
84	552.70.692
135	552.70.697
199	552.70.698

Packing: 1 pair

Panel for internal pull out D

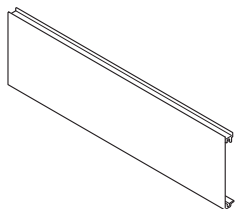

> Material: Aluminium
> Length: 1,100 mm

Color	Cat. No.
Grey	552.69.981

Packing: 1 piece

Cross rail E

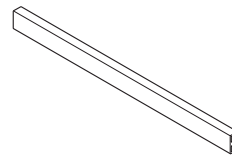

- Area of application: For internal drawer with rear panel height 135 mm and 199 mm
- Material: Aluminium
- Length: 1,100 mm

Color	Cat. No.
Grey	552.72.617

Packing: 1 piece

Bracket



Finish	Dimension	Cat. No.
White	18 kg 75 x 100 mm	287.30.108
	20 kg 100 x 125 mm	287.30.117
	20 kg 125 x 150 mm	287.30.126
	25 kg 150 x 200 mm	287.30.144
	25 kg 200 x 250 mm	287.30.162
	30 kg 250 x 300 mm	287.30.171
Brown	35 kg 300 x 350 mm	287.30.180
	18 kg 75 x 100 mm	287.30.206
	20 kg 100 x 125 mm	287.30.215
	20 kg 125 x 150 mm	287.30.224
	25 kg 150 x 200 mm	287.30.242
	25 kg 200 x 250 mm	287.30.260
30 kg 250 x 300 mm	287.30.269	
35 kg 300 x 350 mm	287.30.288	



Shelf Support



Description	Material	Cat. No.
Shelf support brown 5 mm	Plastic, pin steel	482.05.440
Shelf support transparent 5mm		482.05.441



Description	Material	Cat. No.
Shelf support Galvanized 5mm for wooden shelves	Steel	482.05.081

Floor Glide



Description	Material	Cat. No.
Furniture glide white Ø 10 mm	Plastic	486.02.167
Furniture glide white Ø 22 mm		486.02.168



Description	Material	Cat. No.
Base Leveler, 1/4-20x22 mm	Screw: Steel pl.	486.02.293

Adjusting Screw



Description	Material	Cat. No.
Adjusting screw galv.M8x45 mm	Screw: Steel pl.	486.01.054

Adjusting Plinth Foot



Description	Finish	Cat. No.
Plinth adjusting foot black 100 mm	Plastic	496.80.316

Drawer lock



Description	Finish	Cat. No.
Econo drawer lock 19/22 mm backset 24 mm	Chrome plated polished	482.01.100

Aluminum Wardrobe Rail Set



Description	Finish	Cat. No.
Wardrobe Rail Set 1000 mm	Aluminum	498.02.052
Wardrobe Rail Set 2000 mm		498.02.053

Each Set Consist of:
Aluminum Wardrobe Tube

Table Leg



Finish	Cat. No.
White 60 x 710 mm	496.22.012
Black 60 x 710 mm	496.22.011
Stainless Steel 60 x 710 mm	496.22.015
Chrome Plated Polished 60 x 710 mm	496.22.010

Luxury Grip Handle Set



Technical Drawing

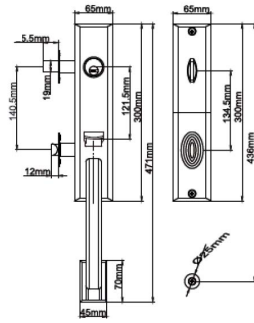

Entrance

Finish	Cat. No.
Black	911.83.580



Technical Drawing

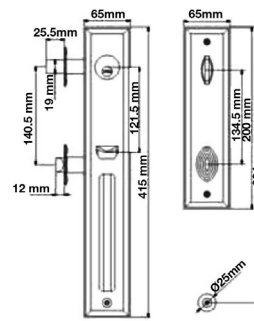

Entrance

Finish	Cat. No.
Dim Satin Nickel	911.64.600



Technical Drawing

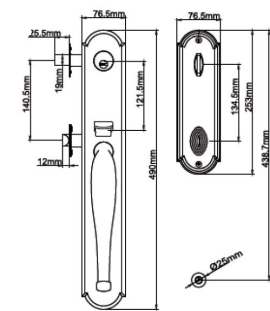

Entrance

Finish	Cat. No.
Black	911.83.578



Technical Drawing

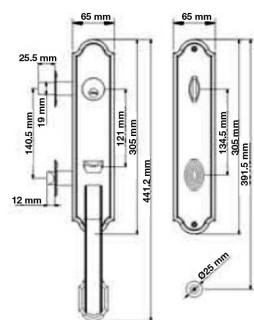

Entrance

Finish	Cat. No.
Satin Nickel	911.64.596



Technical Drawing

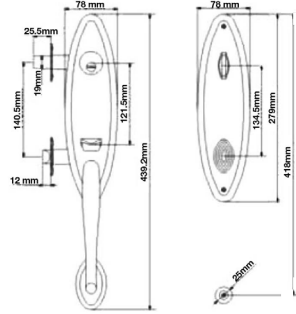

Entrance

Finish	Cat. No.
Dim Antique Brass	911.64.592



Technical Drawing

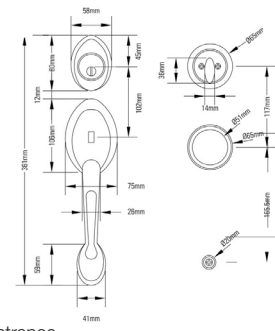

Entrance

Finish	Cat. No.
Satin Nickel	489.10.630
Antique Brass	489.10.628
Black	489.10.636



Technical Drawing

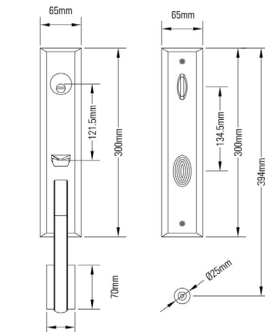

Entrance

Finish	Cat. No.
Satin Nickel	489.10.623
Antique Brass	489.10.625



Technical Drawing

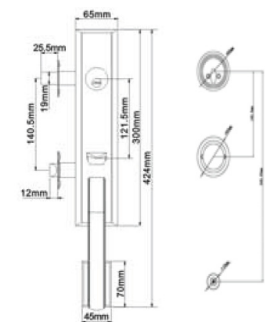

Entrance

Finish	Cat. No.
Satin Nickel / Nickel Polished	911.78.290



Technical Drawing

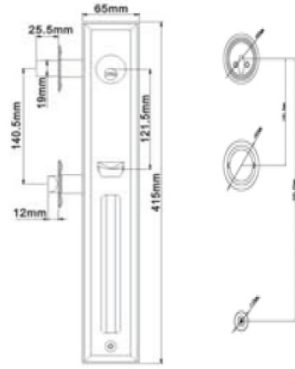

Entrance

Finish	Cat. No.
Satin Nickel / Nickel Polished	911.78.310



Technical Drawing

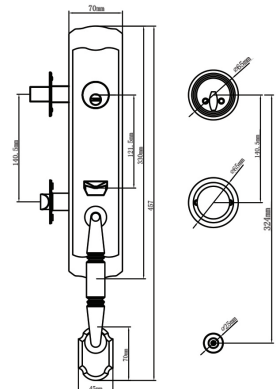

Entrance

Finish	Cat. No.
Satin Nickel	911.78.287



Technical Drawing

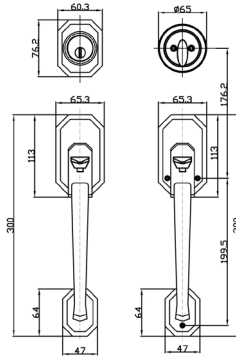

Entrance

Finish	Cat. No.
Satin Nickel	489.94.311
Antique Brass	489.94.312



Technical Drawing

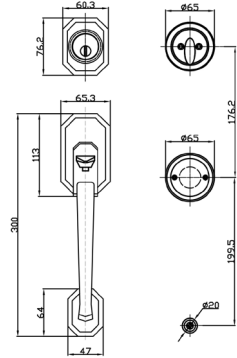

Entrance

Finish	Cat. No.
Satin Nickel	911.64.552
Antique Brass	911.64.554



Technical Drawing

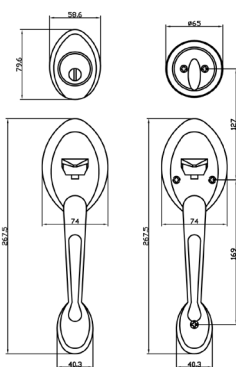

Entrance

Finish	Cat. No.
Satin Nickel	489.94.315
Antique Brass	489.94.316



Digital door lock DL7000



- 3 identification types:
 - Up to 50 key cards/tags(Mifare and Rabbit Cards)
 - Up to 50 passwords (6-16 digits combination)
 - Mechanical key override.
- Setting menu via OLED display screen.
- Digital touchpad design.
- Passage mode available.
- Random security coding function.
- Low battery power alert and intrusion warning function.
- Mischief and hacking prevention system.
- Micro USB emergency power supply.
- Suitable for DIN left and DIN right.
- Suitable for door leaf thickness 35 - 50 mm.
- Dimension(WxHxD)
 - External module: 64 x 283 x 27 mm
 - Internal module: 64 x 283 x 27 mm
 - Standard mortise lock: 80 x 140 x 24 mm (backset 60 mm)
 - High security mortise lock: 80 x 240 x 24 mm (backset 60 mm)

Supplied with
1 External and internal module, 1 Set of striking plate,
1 Set of fixing material, 2 Key tags, 2 Mechanical keys
1 User manual, Installation guide and Installation template

Finish		Cat. No.
Black	With Biometric	912.20.320

- 3 identification types:
 - Up to 50 key cards/tags(Mifare and Rabbit Cards)
 - Up to 50 passwords (6-16 digits combination)
 - Mechanical key override.
- Setting menu via OLED display screen.
- Digital touchpad design.
- Passage mode available.
- Random security coding function.
- Low battery power alert and intrusion warning function.
- Mischief and hacking prevention system.
- Micro USB emergency power supply.
- Suitable for DIN left and DIN right.
- Suitable for door leaf thickness 35 - 50 mm.
- Dimension(WxHxD)
 - External module: 64 x 283 x 27 mm
 - Internal module: 64 x 283 x 27 mm
 - Standard mortise lock: 80 x 140 x 24 mm (backset 60 mm)
 - High security mortise lock: 80 x 240 x 24 mm (backset 60 mm)

Supplied with
1 External and internal module, 1 Set of striking plate,
1 Set of fixing material, 2 Key tags, 2 Mechanical keys
1 User manual, Installation guide and Installation template

Finish		Cat. No.
Black matt	Standard	912.20.300

ER6100-TC (CR1000K)



Feature and Specifications

- Automatic locking
- Internal force lock (Privacy mode)
- Fake PIN code (PIN scramble)
- High temperature alert
- Burglar (Break in/Damage) Alarm
- Wrong-try lock-out
- Emergency power supply (9V)
- Residential/Commercial Mode
- Low battery notification
- One time manner mode
- Volume control
- Register up to 30 RFID Cards
- Register up to 30 PIN codes

Item Description	Cat. No.
Rim lock	912.20.215

Digital Door Viewer
3.5"TFT screen door viewer recordable

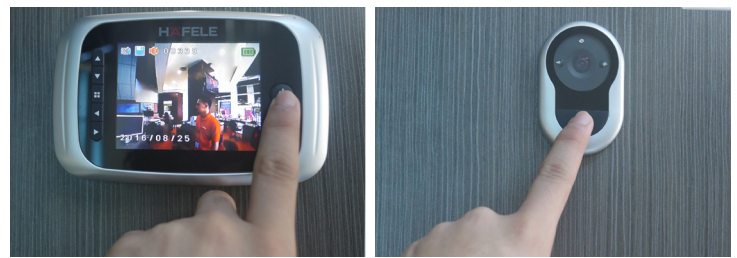

Features and advantages:

- 3.5"TFT screen door viewer recordable (Color: silver)
- Sensor: 0.3 Mega Pixel CMOS
- LCD screen: 3.5" TFT
- View angle: 110 degree
- Fits door:40-70mm thickness
- Fits any barrel hole: 14-26mm
- 512TF card, max. 8GB
- Automatic image pickup
- Doorbell function
- Video recording function
- Power source: 4 AA Batteries (good for approx. 2000 "peep")
- Overall size(L x T x H): 135x25x86mm

Overall Size (LxTxH)	Cat. No.
135x25x86 mm	959.23.050

Cylindrical Knob Lockset
Door Thickness: 35-45 mm



Function	Finish	Cat. No.
Entrance	Stainless Steel Matt	489.10.000
	Antique Brass	489.10.001



Function	Finish	Cat. No.
Entrance	Stainless Steel Matt	489.10.400
	Antique Brass	489.10.402
Privacy	Stainless Steel Matt	489.10.404
	Antique Brass	489.10.406

Door Thickness: 35-50 mm



Function	Finish	Cat. No.
Entrance	Stainless Steel Matt	489.10.064
	Antique Brass	489.10.039
Privacy	Stainless Steel Matt	489.10.065
	Antique Brass	489.10.042



Function	Finish	Cat. No.
Entrance	Black matt	489.10.067

Door Thickness: 35-50 mm



Function	Finish	Cat. No.
Entrance	Stainless Steel Matt	489.10.454
Privacy	Stainless Steel Matt	489.10.456

Door Thickness: 35-50 mm



Function	Finish	Cat. No.
Entrance	Stainless Steel Matt	489.10.450
Privacy	Stainless Steel Matt	489.10.452

Tubular Lockset
Door Thickness: 35-45 mm



Function	Finish	Cat. No.
Entrance	Stainless Steel Matt	489.10.152
Privacy	Stainless Steel Matt	489.10.153

Cylindrical Knob Lockset
ANSI Grade 2 UL Listed
Heavy Duty
Door thickness: 35 - 45 mm



Function	Finish	Cat. No.
Entrance	Stainless Steel Matt	489.10.700
Privacy	Stainless Steel Matt	489.10.701

Deadbolt Lock
Door Thickness: 35-50 mm



Finish	Cat. No.
Stainless Steel	489.16.001
Antique Brass	489.16.002
Black matt	489.16.006



Finish	Cat. No.
Stainless Steel	489.16.004
Antique Brass	489.16.005

Door Thickness: 35-45 mm



Finish	Cat. No.
Stainless Steel	489.10.124
Antique Brass	489.10.126

Finish	Cat. No.
Stainless Steel	489.10.121
Antique Brass	489.10.123

Knob with Cylindrical
Deadbolt Lock
Door Thickness: 35-50 mm



Finish	Cat. No.
Stainless Steel Matt	489.10.059

Tubular Lever Lockset
Standard Duty
Door Thickness: 35-50 mm



Left Hand	Finish	Cat. No.
Entrance	Antique Brass	489.10.097
	Satin nickel	489.10.099

Right Hand	Finish	Cat. No.
Entrance	Satin nickel	489.10.098
	Antique Brass	489.10.096



Right Hand	Finish	Cat. No.
Entrance	Antique Brass	489.10.084
	Satin Nickel	489.10.086
Privacy	Antique Brass	489.10.090
	Satin Nickel	489.10.092

Left Hand	Finish	Cat. No.
Entrance	Antique Brass	489.10.085
	Satin Nickel	489.10.087
Privacy	Antique Brass	489.10.091
	Satin Nickel	489.10.093



Function	Finish	Cat. No.
Entrance	Satin Nickel	911.64.432
	Antique Brass	911.64.433
Privacy	Satin Nickel	911.64.435
	Antique Brass	911.64.436



Function	Finish	Cat. No.
Entrance	Antique Brass	489.10.296
Privacy	Antique Brass	489.10.297
Entrance	Satin Nickel	489.10.293
Privacy	Satin Nickel	489.10.294



Function	Finish	Cat. No.
Entrance	Satin Nickel	489.10.287
Entrance	Antique Brass	489.10.290
Privacy	Satin Nickel	489.10.288
Privacy	Antique Brass	489.10.291

Cylindrical Lever Lockset
ANSI Grade 2 UL Listed
Heavy Duty
Door Thickness: 35 - 45 mm



Function	Finish	Cat. No.
Entrance	Satin nickel	911.83.412
Privacy	Satin nickel	911.83.413



Function	Finish	Cat. No.
Entrance	Satin nickel	911.83.418
Privacy	Satin nickel	911.83.419

Cylindrical Lever Lockset
Heavy Duty
Door Thickness: 35-45 mm



Function	Finish	Cat. No.
Entrance	Satin Nickel	489.10.137



Function	Finish	Cat. No.
Privacy	Satin Nickel	489.10.140

Cylindrical Lever Lockset
Standard Duty
Door Thickness: 35-50 mm



Function	Finish	Cat. No.
Entrance	Satin Nickel	489.10.034
Privacy	Satin Nickel	489.10.035

Combo Lock set
Lever set + Single Deadbolt
Standard Duty
Door Thickness: 35-50 mm



Function	Finish	Cat. No.
Entrance	Satin nickel + Stainless steel	489.10.069



Tubular Lever Set
ANSI Grade 3
Door thickness: 35-45 mm



Function	Finish	Cat. No.
Entrance	Satin Stainless Steel	489.10.692
Privacy	Satin Stainless Steel	489.10.693

Tubular Lever Set
Heavy Duty
Door thickness: 35-50 mm



Function	Finish	Cat. No.
Entrance	Satin nickel	489.10.580
	Antique brass	489.10.581
Privacy	Satin nickel	489.10.582
	Antique brass	489.10.583

Tubular Lever Set
Heavy Duty
Door thickness: 35-50 mm



Function	Finish	Cat. No.
Entrance	Satin nickel	489.10.584
	Antique brass	489.10.585
Privacy	Satin nickel	489.10.586
	Antique brass	489.10.587

Tubular Lever Set
Standard Duty
Door thickness: 35-50 mm



Right handle

Function	Finish	Cat. No.
Entrance	Satin nickel	489.10.760
	Antique brass	489.10.761
Privacy	Satin nickel	489.10.762
	Antique brass	489.10.763

Left handle

Function	Finish	Cat. No.
Entrance	Satin nickel	489.10.860
	Antique brass	489.10.861
Privacy	Satin nickel	489.10.862
	Antique brass	489.10.863



Function	Finish	Cat. No.
Entrance	Satin nickel	489.10.764
	Antique brass	489.10.765
Privacy	Satin nickel	489.10.766
	Antique brass	489.10.767



Function	Finish	Cat. No.
Entrance	Satin nickel	489.10.768
	Antique brass	489.10.769
Privacy	Satin nickel	489.10.770
	Antique brass	489.10.771

Door Thickness: 35-45 mm



Function	Finish	Cat. No.
Entrance	Satin nickel	911.64.534

Complete Set:
Lever handle
Mortise lock
Profile cylinder

Mortise Lever Handle Set
Inclusive of
Mortise Lockset
Door Thickness: 38-42 mm



Stainless Steel Matt	Cat. No.
Entrance	489.10.460

Inclusive of
Mortise Lockset



Stainless Steel Matt	Cat. No.
Entrance	489.10.462



- Area of application: For rebated or flush wooden doors
- Material: For end: Stainless Steel, Latch bolt, Deadbolt and Lock Case, Brass, Lever Follower: Sinter Metal
- Closure: Prepared for profile cylinder
- Deadbolt: 2-turn
- Version: With key action
- For end: Square
- Lever Follower: 8 mm
- Distance B :72 mm
- Backset 55 mm



Butt Hinges

2 Ball Bearing Butt Hinge

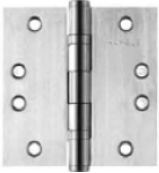

Finish/Dimension	Cat. No.
Stainless Steel 102 mm x 102 mm x 2.5 mm	489.20.012
Antique Brass 102 mm x 102 mm x 2.5 mm	489.20.013

2 Ball Bearing Butt Hinge

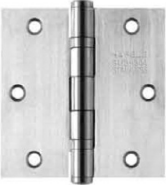

Finish/Dimension	Cat. No.
Stainless Steel 89 mm x 89 mm x 2.5 mm	489.20.009
Antique Brass 89 mm x 89 mm x 2.5 mm	489.20.010

2 Ball Bearing Butt Hinge



Finish/Dimension	Cat. No.
Satin Stainless steel 102 mm x 76 mm x 2 mm	489.04.000
Black 102 mm x 76 mm x 2 mm	489.04.023

2 Ball Bearing Butt Hinge

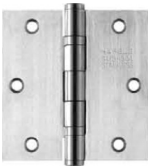

Finish/Dimension	Cat. No.
Satin Stainless steel 76 mm x 76 mm x 2 mm	489.20.027
Satin Stainless steel 76 mm x 51 mm x 2 mm	489.20.028

Loose Pin Butt Hinge



Finish/Dimension	Cat. No.
Stainless Steel Matt 102 mm x 76 mm x 2.5 mm	489.04.021
Stainless Steel Matt 89 mm x 89 mm x 2.5 mm	489.04.022

Flush Hinge



Finish/Dimension	Cat. No.
Stainless Steel Matt 102 mm x 75 mm x 2.5 mm	489.04.020

Spring Hinge



Finish	Cat. No.
Stainless steel 102 mm	489.02.310

Double Action Spring Hinge



Finish	Cat. No.
Stainless steel 102 mm	489.02.602

2 Ball Bearing Butt Hinge

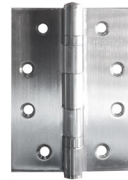

Finish/Dimension	Cat. No.
Black matt 102 x 76 x 2 mm	489.04.023
Stainless steel matt 102 x 76 x 2 mm	489.04.000

Concealed Hinge



Description	Door thicknesses	Nickel Plated
		Cat. No
Without plastic slide plates	13-16 mm	341.07.718
	19-24 mm	341.07.727
		341.07.736
	25-27 mm	341.07.745
	28-34 mm	341.07.754
With plastic slide plates	35-38 mm	341.07.763
	41-45 mm	341.07.772
	48-51 mm	341.07.781



Finish	Cat. No.
Zinc alloy Chrome plated satin	341.18.431

Door thickness: 38-43

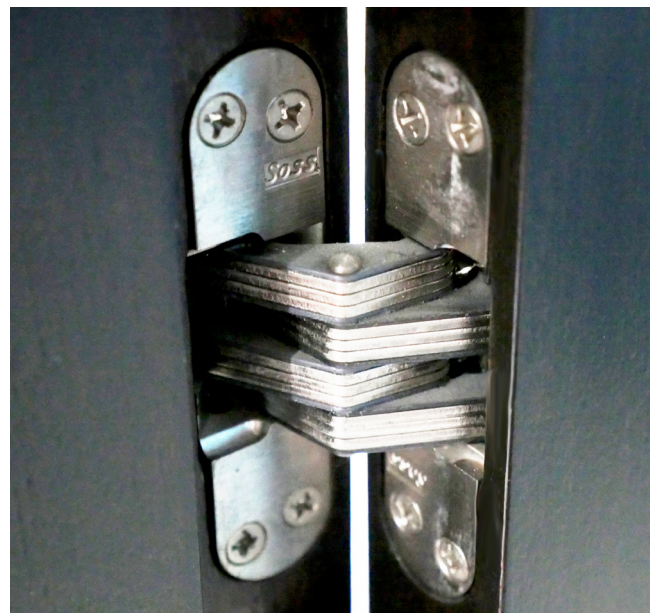

Door Closer
Max. Opening - 180°

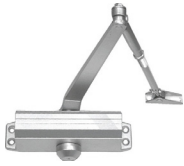

Description	Cat. No.
With standard arm / 40 kg	489.30.006
With hold open-arm / 40 kg	489.30.007



Description	Cat. No.
With standard arm / 60 kg	489.30.004
With hold open-arm / 60 kg	489.30.005



Description	Cat. No.
EN3 850 mm / 60 kg	489.30.000

Description	Cat. No.
Door closer silver, w/o hold open / 80 kg	499.30.002
Door closer silver, w/ hold open 90° / 80 kg	499.30.003



Description	Cat. No.
With Standard arm/ 80 kg	489.30.001

Concealed Door Closer



Description	Cat. No.
With Hold Open-Arm/ 60 kg	931.77.019



Description	Cat. No.
With Standard Arm/ 60 kg	931.84.049
With Hold Open-Arm/ 60 kg	931.84.279



Description	Cat. No.
With Standard Arm/ 80 kg	931.84.039
With Hold Open-Arm/ 80 kg	931.84.269

Floor spring



Description	Cat. No.
DCL 41 hold open angle 90°, open angle 130°, 105 kg	932.84.030
DCL 41 hold open angle 90°, open angle 130°, 250 kg	932.84.031



Door Width	Door Weight	Cat. No.
750 - 850 mm	80 kg	932.79.020
850 - 1000 mm	100 kg	932.79.030
1000 - 1200 mm	120 kg	932.79.040



Description	Cat. No.
Accessories for floor spring	932.79.090

Panic Device



Finish	Cat. No.
Aluminum	911.52.633
Aluminum (Fire Rated)	911.52.634



Finish	Cat. No.
Satin Chrome	911.56.038



Finish/Dimension	Cat. No.
Stainless Steel - 8 in x 3/4 in	489.71.456
Antique Brass - 8 in x 3/4 in	489.71.458



Finish/Dimension	Cat. No.
Black - 8 in x 3/4 in	489.71.459



Finish	Cat. No.
Stainless steel matt (304)	489.71.430

Door Stopper
Wall mounted



Finish	Cat. No.
Satin Chrome	489.70.191
Antique Brass	489.70.193



Finish	Cat. No.
Stainless steel matt	489.70.279



Finish	Cat. No.
Satin stainless steel	489.70.199



Finish	Cat. No.
Stainless steel matt	489.70.205

Floor mounted



Finish	Cat. No.
Antique Brass	489.70.132
Chrome Polished	489.70.134
Satin Nickel	489.70.130



Finish	Cat. No.
Satin Stainless steel	489.70.254



Finish	Cat. No.
Black	489.70.278
Antique Brass	489.70.234
Satin Chrome	489.70.237

Door Chain



Finish	Cat. No.
Stainless Steel Matt	489.71.571



Finish	Cat. No.
Zinc Nickel Matt	489.71.575

Security Door Guard



Finish	Cat. No.
Satin Chrome	489.15.006
Antique Brass	489.15.008
Black	489.15.009

Door Bolt



Finish	Cat. No.
Stainless Steel Matt - 102 mm	489.71.360
Stainless Steel Matt - 152 mm	489.71.364

Engineering bolt



Finish	Cat. No.
Stainless steel matt	489.71.063

Security Door Guard



Finish	Cat. No.
Stainless /70 mm	489.71.670
Stainless /100 mm	489.71.674

Indicator bolt



Finish	Cat. No.
Stainless steel matt (304)	489.71.062

Window Hook



Finish	Cat. No.
Stainless Steel Matt - 152 mm	489.71.810

Door Viewer

200°
Ø16 mm; 35-55 mm



Finish	Cat. No.
Satin Nickel	489.70.425
Chrome Polished	489.70.432
Antique Brass	489.70.431



Finish	Cat. No.
Black	489.70.447

Door Seal



Description	Cat. No.
E Shape - Brown Adhesive 2 X 2.5 m	489.41.104
E Shape - Grey Adhesive 2 X 2.5 m	489.41.105
E Shape - Black Adhesive 2 X 2.5 m	489.41.107



Description	Cat. No.
P Shape - Brown Adhesive 2 X 2.5 m	489.41.114
P Shape - Gray Adhesive 2 X 2.5 m	489.41.115
P Shape - Black Adhesive 2 X 2.5 m	489.41.117



Description	Cat. No.
D Shape - Brown Adhesive 2 X 2.5 m	489.41.124
D Shape - Black Adhesive 2 X 2.5 m	489.41.127



Description	Cat. No.
Door brush seal Gray 5 m	489.41.041



Finish - Material	Cat. No.
Aluminum Silver Anodized	489.97.902
Aluminum Brown	489.97.102

•Screw on



Finish - Material	Cat. No.
Polypropylene Brown	489.97.101

•Adhesive

Rubber seal

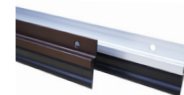

Finish	Cat. No.
Aluminium brown	489.97.107
Aluminium Anodized	489.97.907

Push Plate.St.St.Matt

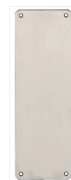

Dimension	Cat. No.
300 x 100 x 1.5 mm w/ text push	987.11.340
300 x 100 x 1.5 mm	987.11.610
350 x 100 x 1.5 mm	987.11.090
200 X 910 X 1.5 mm	987.13.200

Pull Plate.St.St.Matt



Finish	Cat. No.
300 x 100 x 1.5 mm w/ text pull	987.11.240
300 x 100 x 1.5 mm	987.11.510
350 x 100 x 1.5 mm	987.11.190



Entrance

Finish	Cat. No.
Ant. Brass	499.10.250
Sat. Nickel	499.10.251

Bathroom

Finish	Cat. No.
Antique Brass	499.10.252
Sat. Nickel	499.10.253

Double Cylinder

Finish	Cat. No.
Satin Nickel	499.10.256

Dummy

Finish	Cat. No.
Antique Brass	499.10.254
Satin Nickel	499.10.255



Finish	Cat. No.
Satin Stainless Steel, 125 x 51 mm	489.72.131
Satin Stainless Steel, 150 x 51 mm	489.72.132



Entrance

Finish	Cat. No.
Antique Brass	499.10.247
Satin Nickel	499.10.246

Bathroom

Finish	Cat. No.
Antique Brass	499.10.257
Satin Nickel	499.10.258

Dummy

Finish	Cat. No.
Satin Nickel	499.10.259



Finish	Cat. No.
Satin Stainless Steel	489.72.133



Entrance

Finish	Cat. No.
Dim. Satin Nickel	499.10.260

Bathroom

Finish	Cat. No.
Dim. Antique Brass	499.10.261
Dim. Satin Nickel	499.10.262

Dummy

Finish	Cat. No.
Dim. Antique Brass	499.10.263
Dim. Satin Nickel	499.10.264



Sliding Door Fitting Silent 30/A

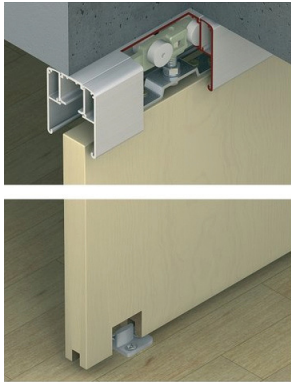

30 kg Door Weight



Running Gear with Wheel Suspension Screw set in DIY pack

Silent 30/A	Description	Cat. No.
	Fitting set for 1-leaf sliding door, without running track	499.40.003

Running Track

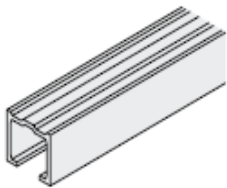

Length	Cat. No.
2000 mm	499.40.011
3000 mm	499.40.012



Sliding Door Fitting Silent 60/A and 100/A

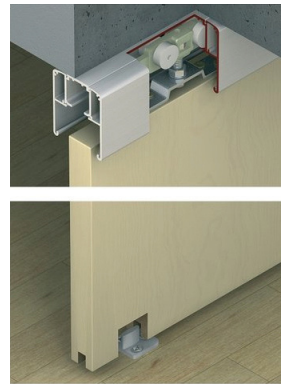

Running Gear with Wheel Suspension Screw set in DIY pack

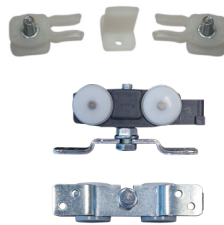
Silent 60/A	Description	Cat. No.
	Fitting set for 1-leaf sliding door, without running track	499.40.004

Running Gear with Wheel Suspension Screw set in DIY pack

Silent 100/A	Description	Cat. No.
	Fitting set for 1-leaf sliding door, without running track	499.40.005

Running Track

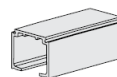

Length	Cat. No.
2000 mm	499.40.014
3000 mm	499.40.015

Running Track

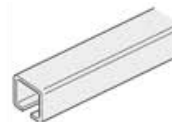

Length	Cat. No.
2000 mm	499.40.082
3000 mm	499.40.083

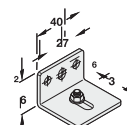

Note:
Install wall mounting brackets in intervals of 400 mm.

Description	Cat. No.
Wall mounting bracket, steel galvanized, with screw and nut	499.40.302

Sliding Door Fitting Silent 160/A

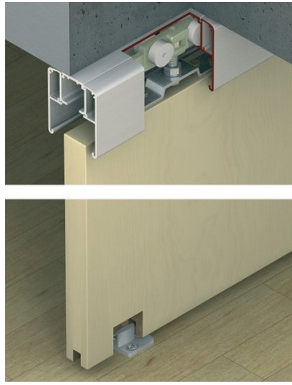

160 kg Door Weight Capacity



Running Gear with Wheel Suspension Screw set in DIY pack

Silent 160/A	Description	Cat. No.
	Fitting set for 1-leaf sliding door, without running track	499.40.008

Running Track

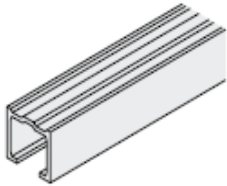

Length	Cat. No.
2000 mm	499.40.017
3000 mm	499.40.018

Add-on Accessories:

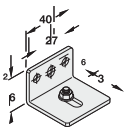

Description	Cat. No.
Wall mounting bracket, steel galvanized, with screw and nut	499.40.301

Without Cover Plates

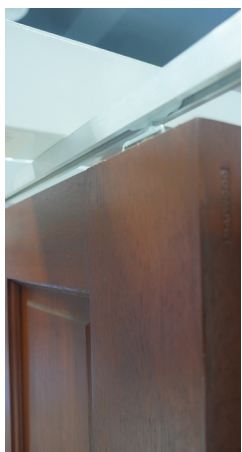

Cover Plates Mounting



Sliding Door Fitting Silent 250/A

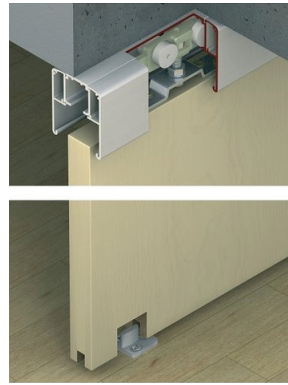

250 kg Door Weight Capacity



Running Gear with Wheel Suspension Screw set in DIY pack

Silent 250/A	Description	Cat. No.
	Fitting set for 1-leaf sliding door, without running track	499.40.006

Running Track

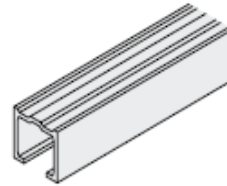

Length	Cat. No.
2000 mm	499.40.022
3000 mm	499.40.023

Add-on Accessories:

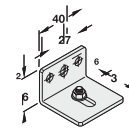

Description	Cat. No.
Wall mounting bracket, steel galvanized, with screw and nut	499.40.301

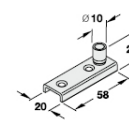

Description	Cat. No.
Floor guide roller Ø 10 mm, steel galvanized	
Guide w/ roller	499.40.300

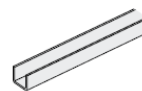

U Shape Guide	Cat. No.
Guide rail alu nat. - 200 m	499.40.212
Guide rail alu nat. - 300 m	499.40.213



Description	Cat. No.
Adjustable Bottom Guide	940.40.073



Description	Cat. No.
Upper Pivot	941.04.021



Description	Cat. No.
Lower Pivot	941.04.033

Flat bar sliding door (loft style)



Installation: Wall mounting

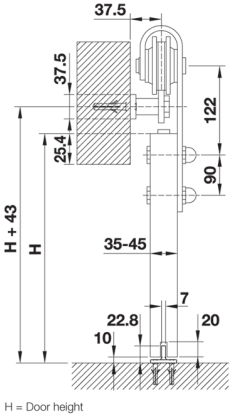
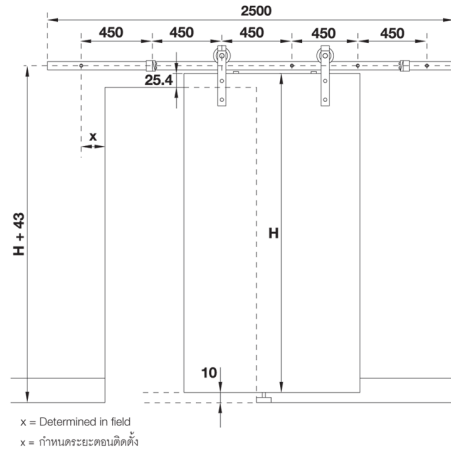

Features:

- For 1- leaf wooden sliding door
- Wall mounting installation

Technical data:

- Max. door weight 100 kg
- Max. door height 2,500 mm
- Max. door width 1,200 mm
- Door thickness 35-45 mm

Sliding door fitting set	Material	Finish	Length mm	Cat. No.
 Without soft close mechanism	Steel	Black	2,500	941.32.004

Packing: 1 set

Flat bar sliding door (loft style)



Installation: Wall mounting

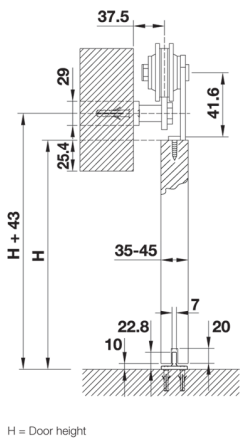
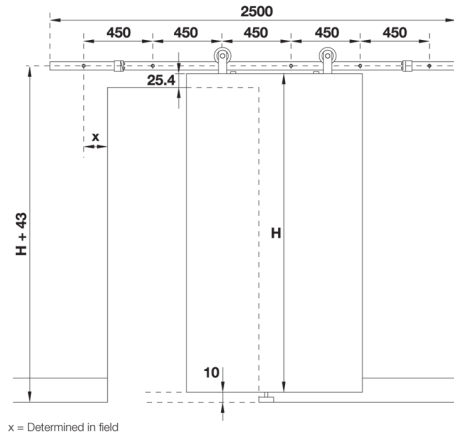

Features:

- For 1- leaf wooden sliding door
- Wall mounting installation

Technical data:

- Max. door weight 100 kg
- Max. door height 2,500 mm
- Max. door width 1,200 mm
- Door thickness 35-45 mm

Sliding door fitting set	Material	Finish	Length mm	Cat. No.
 Without soft close mechanism	Stainless steel	Matt	2,500	941.32.014

Packing: 1 set

Häfele Slido Classic 50-P to 120-P Sliding door fitting



Soft and self closing mechanism:

- > Low opening force – easy and convenient operation
 - > Tested with increased speed up to 0.5 m/s
 - > Can be retrofitted or replaced at any time
- Shock absorber:
- > Closing speed with shock absorber tested up to 0.4 m/s



- > Area of application: For 1-leaf and 2-leaf sliding doors
- > Door weight: <50/80/120 kg
- > Adjustment facility: Door height adjustable
- > Installation: Suspension with screwed on support flange, wall mounting and ceiling installation

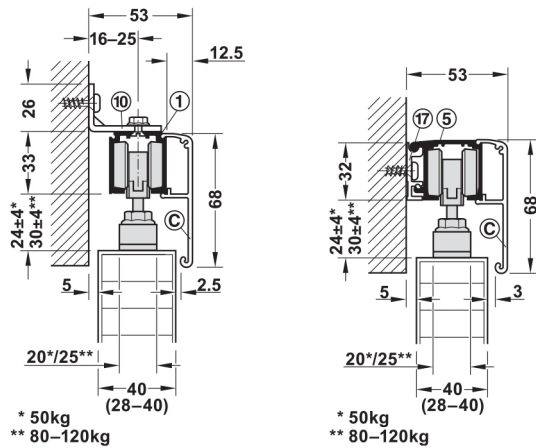

Wall mounting with mounting bracket

Wall mounting with mounting rail

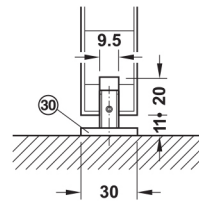

Clear threshold floor guide (30) without guide track

Note
End cap for ceiling installation with fascia on both sides not available. One pair of end caps can be glue fixed vertically in the centre of the running track (optional).

Soft closing versions overview
Running gear with axle bearing

Without soft and self closing mechanism

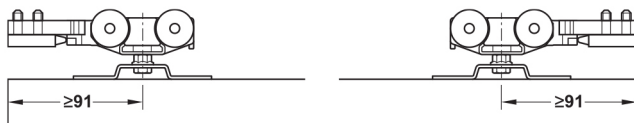

With soft and self closing mechanism on one side

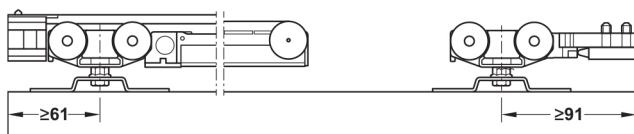

Running gear with ball bearing mounted rollers

With soft and self closing mechanism on one side and shock absorber

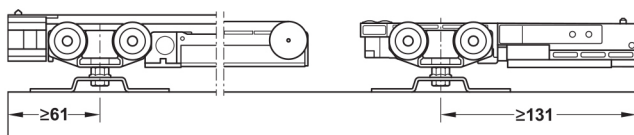

With soft and self closing mechanism on both sides

Section trolley hanger and guide

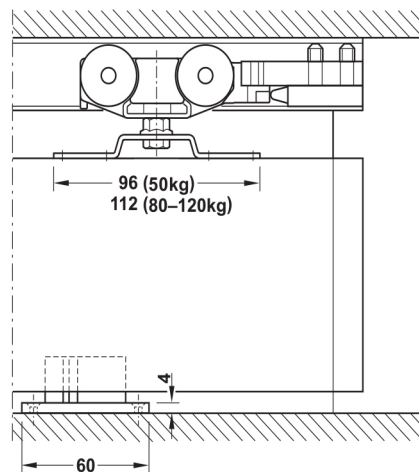

Set without running track for 1 door

Version		Supplied with	Door width mm	50-P <50 kg per door	80-P <80 kg per door	120-P <120 kg per door
Running gear with axle bearing						
Without soft and self closing mechanism	Track buffer with retaining spring	2 running gears 1 clear threshold floor guide 2 track buffers with retaining spring	>500	940.42.064	940.83.005	941.02.036
With soft and self closing mechanism on one side	Track buffer with retaining spring	2 running gears (1 with soft and self closing mechanism) 1 clear threshold floor guide 1 track buffer with retaining spring 1 release device with stopper for soft and self closing mechanism	>499 (50 and 80 kg) >561 (120 kg)	940.42.065	940.83.006	941.02.037
Running gear with ball bearing mounted rollers						
With soft and self closing mechanism on one side	Shock absorber with retaining spring	2 running gears (1 with soft and self closing mechanism) 1 clear threshold floor guide 1 shock absorber with retaining spring 1 release device with stopper for soft and self closing mechanism	>558 (50 and 80 kg) >620 (120 kg)	940.42.066	940.83.007	941.02.038
With soft and self closing mechanism on both sides	–	2 running gears with soft and self closing mechanism 1 clear threshold floor guide 2 release devices with stopper for soft and self closing mechanism	>744 (50 and 80 kg) >868 (120 kg)	940.42.067	940.83.008	941.02.039

Order reference

Please order track, panels and accessories separately. Order 2 sets for 2-leaf sliding doors.

Note

Please note when using the shock absorber with retaining spring: The door may not close completely if the closing speed is too low, if it is too high, the door may bounce back slightly.
For sets without or with soft and self closing mechanism on one side: Soft and self closing mechanism or shock absorber can be retrofitted, if required.

Running Track

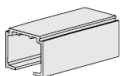

Length	Cat. No.
2000 mm	499.40.014
3000 mm	499.40.015

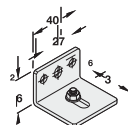

Note:
Install wall mounting brackets in intervals of 400 mm.

Description	Cat. No.
Wall mounting bracket, steel galvanized, with screw and nut	499.40.302

Häfele Slido Classic Synchro
Additional set for Classic 50-P to 120-P
sliding door fittings

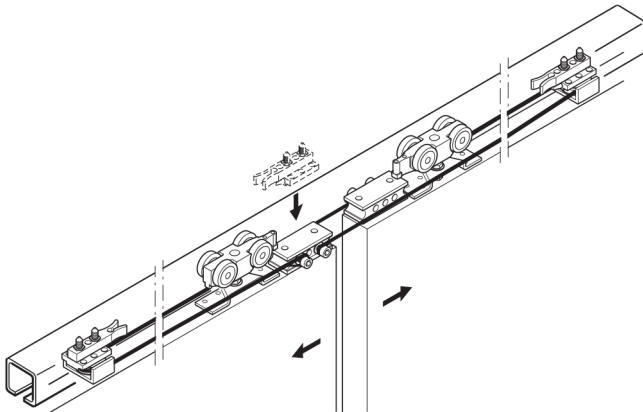

- > Area of application: For 2-leaf sliding doors
- > Functionality: For symmetrical opening of 2 door leaves
- > Door width: >600 and <1,500 mm

Note

The additional set can only be used in conjunction with basic equipment consisting of two sets for 1-leaf sliding doors (Classic 40-P, 60-P, 80-P or 120-P) and running track.
Not suitable for versions with soft and self closing mechanism.

Dimension	Dimension	Cat. No.
For 2-leaf sliding doors	2 track buffers with deflection roller 1 cable without plastic sheathing, length 10 m 2 cable fixing blocks	940.44.002

Top Mount Built-In Sinks
Single bowl - Stainless Steel



Round Sink with Tap Hole

Dimension	Cat. No.
Diameter: 510 x 170 mm	567.52.000

•Cut out Dimension: Ø490



Dimension	Cat. No.
500 x 500 x 170 mm	567.50.190

•Cut out Dimension: 490 x 490mm



Dimension	Cat. No.
635 x 561 x 210 mm	567.50.180

•Cut out Dimension: 550 x 407 mm



Single bowl with drain - Stainless Steel



Dimension	Cat. No.
RHB 625 x 500 x 170 mm	567.50.231
LHB 625 x 500 x 170 mm	567.50.232

•Cut out Dimension: 400 x 525 mm



Dimension	Cat. No.
A-RHB 820 x 470 x 170 mm	567.50.121
A-LHB 820 x 470 x 170mm	567.50.122
B-RHB 1000 x 500 x 170 mm	567.50.101
B-LHB 1000 x 500 x 170 mm	567.50.102

•Cut out Dimension: A: 780 x 430, B: 960 x 460 mm



Dimension	Cat. No.
RHB 790 x 485 x 170 mm	567.50.131
LHB 790 x 485 x 170 mm	567.50.132

•Cut out Dimension: 455 x 760 mm



Dimension	Cat. No.
RHB 820 x 470 x 190 mm	567.50.331
LHB 820 x 470 x 190 mm	567.50.332

•Cut out Dimension: 370 x 740 mm

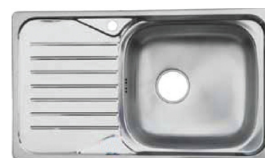

Dimension	Cat. No.
RHB 820 x 470 x 170mm	567.50.281
LHB 820 x 470 x 170 mm	567.50.282

•Cut out Dimension: 370 x 740 mm



Dimension	Cat. No.
RHB 1000 x 500 x 170 mm	567.50.291
LHB 1000 x 500 x 170 mm	567.50.292

•Cut out Dimension: 400 x 904 mm



Dimension	Cat. No.
RHB 820 x 470 x 170 mm	567.50.311
LHB 820 x 470 x 170 mm	567.50.312

•Cut out Dimension: 370 x 740 mm

Top Mount Built-In Sinks
2 Bowl - Stainless Steel



Dimension	Cat. No.
860 x 435 x 160mm	567.50.140

•Cut out Dimension: 820 x 395 mm



Dimension	Cat. No.
RHB 1000 X 500 x 160 mm	567.50.151
LHB 1000 X 500 x 160 mm	567.50.152

•Cut out Dimension: 960 x 460 mm



Dimension	Cat. No.
RHB 1200 x 500 x 170mm	567.50.111
LHB 1200 x 500 x 170mm	567.50.112

•Cut out Dimension: 1120 x 460 mm



Dimension	Cat. No.
RHB 1200 x 500 x 160 mm	567.50.321
LHB 1200 x 500 x 160 mm	567.50.322

•Cut out Dimension: 1120 x 420 mm

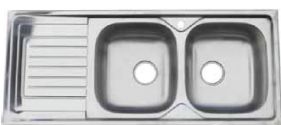

Dimension	Cat. No.
RHB 1200 x 500 x 160 mm	567.50.301
LHB 1200 x 500 x 160 mm	567.50.302

•Cut out Dimension: 1120 x 420 mm



1 Bowl with drain

Dimension	Cat. No.
RHB 1000 x 510 x 200 mm	567.40.071
LHB 1000 x 510 x 200 mm	567.40.072

Cut out Dimension: 970 x 480 mm



2 Bowl with drain

Dimension	Cat. No.
1000 x 510 x 200 mm	567.40.061
Bowl right	567.40.062
1000 x 510 x 200 mm	
Bowl left	

Cut out Dimension: 970 x 480 mm

Under Mount Built-In Sinks
Stainless Steel



1 Bowl

Dimension	Cat. No.
438 x 358 x 190 mm	567.53.053

•Cut out Dimension: 330 x 410 mm



2 Bowl

Dimension	Cat. No.
623 x 470 x 190/140 mm	567.53.043

•Cut out Dimension: 410 x 330 x 330 mm



2 Bowl

Dimension	Cat. No.
750 x 470 x 190 mm	567.53.033

•Cut out Dimension: 690 x 410 mm

Undermount Granite Sink



- Undermount 1 Bowl
- Outer Dimensions: 440 x 440mm
- Bowl Dimensions: 400 x 400 x 200mm
- Material: Quartz composite
- Mounting: Undermount
- Easy to clean
- Heat Resistance up to 200° C only.
- Scratch Resistance

Dimension	Color	Cat. No.
440 x 440 x 200 mm	Carbon	565.89.301
	Grey	565.89.501



- Top mount 1 Bowl with Drain
- Outer Dimensions: 1000 x 500mm
- Bowl Dimensions: 500 x 430 x 205mm
- Material: Quartz composite
- Mounting: Top mounted
- Easy to clean
- Heat Resistance up to 200° C only.
- Scratch Resistance

Dimension	Color	Cat. No.
1000 x 500 x 205 mm	Carbon	565.88.391
	Grey	565.88.591



- Undermount 1 Bowl
- Outer Dimensions: 740 x 440mm
- Bowl Dimensions: 700 x 400 x 200mm
- Material: Quartz composite
- Mounting: Undermount
- Easy to clean
- Heat Resistance up to 200° C only.
- Scratch Resistance

Dimension	Color	Cat. No.
740 x 440 x 200 mm	Carbon	565.89.321
	Grey	565.89.521



- Top mount 1 Bowl with Drain
- Outer Dimensions: 1160 x 500mm
- Bowl Dimensions: 340 x 420 x 205mm
- Material: Quartz composite
- Mounting: Top mounted
- Easy to clean
- Heat Resistance up to 200° C only
- Scratch Resistance

Dimension	Color	Cat. No.
1160 x 500 x 205 mm	Carbon	565.83.341
	Grey	565.88.511

Top mount Granite Sink



- Undermount 1 Bowl
- Outer Dimensions: 860 x 500mm
- Bowl Dimensions: 450 x 420 x 205 mm
300 x 360 205 mm
- Material: Quartz composite
- Mounting: Undermount
- Easy to clean
- Heat Resistance up to 200° C only.
- Scratch Resistance

Dimension	Color	Cat. No.
860 x 500 x 205 mm	Carbon	565.83.351
	Grey	565.88.501



Single lever kitchen mixer tap
(Movable Spout)



Material/Finish	Cat. No.
Brass chrome plated polished	495.50.002

Single Lever Mixer Tap
(Movable Spout)



Material/Finish	Cat. No.
Chrome	570.56.240

Single Lever Kitchen
Cold Taps



Material/Finish	Cat. No.
Stainless Steel	495.50.211

Single Lever Kitchen
Cold Taps



Material/Finish	Cat. No.
Stainless Steel	495.50.212

Single Lever Kitchen
Cold Taps



Material/Finish	Cat. No.
Chrome	566.65.200

Single Lever Kitchen
Cold Taps



Material/Finish	Cat. No.
Chrome	566.08.230
Stainless	566.08.030

Single Lever Kitchen
Mixer Tap



Material/Finish	Cat. No.
Stainless Steel 304	495.50.210

Kitchen Mixer
Goose Neck



Finish	Cat. No.
Chrome	485.50.000

Kitchen Mixer



Finish	Cat. No.
Chrome	485.50.001

Kitchen Mixer Tap
Pull-out Spray



Finish	Cat. No.
Chrome	566.08.020

Packaging: carton

Kitchen Mixer Tap
Pull-out Spray



Material / Finish	Cat. No.
Mixer, with pull out Spray, Carbon	566.76.800
Mixer, with pull out Spray, Grey	566.76.500

Kitchen Mixer Tap



Material / Finish	Cat. No.
Mixer, long spout, Carbon	566.76.820
Mixer, long spout, Grey	566.76.520

HÄFELE



APPLIANCES 2022

Gas Hob Tempered Glass



Technical Drawing

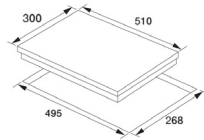

2 burner Gas Hob with Knob Control

Dimensions	Cat. No.
300 x 510 mm	536.06.030

•Cut out Dimension: 268 x 495 mm



Technical Drawing

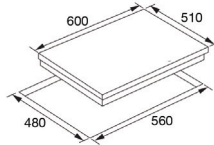

3 burner Gas Hob and 1 zone Electric Hotplate with Knob Control

Dimensions	Cat. No.
600 x 510 mm	536.06.611

•Cut out Dimension: 560 x 480 mm



Technical Drawing

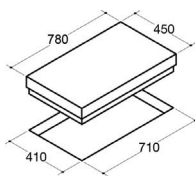

2 burner Gas Hob with Knob Control

Dimensions	Cat. No.
780 x 450 x 115 mm	536.06.665

•Cut out Dimension: 710 x 410 mm



Technical Drawing

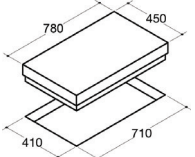

3 burner Gas Hob with Knob Control

Dimension	Cat. No.
780 x 450 x 115 mm	536.06.655

•Cut out Dimension: 710 x 410 mm



Technical Drawing

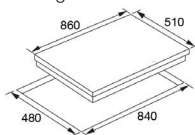

5 Gas Burner Hob

Dimension	Cat. No.
860 x 510 mm	536.06.647

•Cut out Dimension: 840 x 480 mm

Gas Hob, Stainless Steel



Technical Drawing

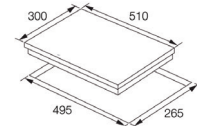

2 burner Gas Hob with Knob Control

Dimension	Cat. No.
310 x 510 x 112 mm	533.02.314

•Cut out Dimension: 258 x 473 mm



Technical Drawing

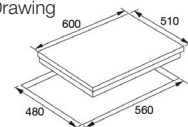

3 burner Gas Hob and 1 zone Electric Hotplate with Knob Control

Dimension	Cat. No.
600 x 510 x 50 mm	536.06.521

•Cut out Dimension: 560 x 480 mm



Technical Drawing

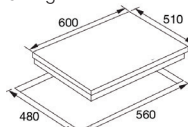

4 burner Gas Hob with Knob Control

Dimension	Cat. No.
600 x 510 x 50 mm	536.06.631

•Cut out Dimension: 560 x 480 mm

Ceramic Hob

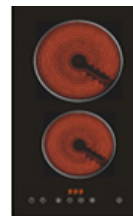

Technical Drawing

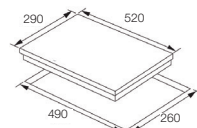

Ceramic Hob with Touch Control 2 Zones

Dimension	Cat. No.
290 x 520 x 67 mm	538.06.490

•Cut out Dimension: 260 x 490 mm

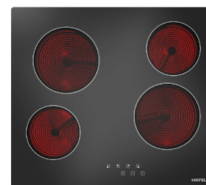

Technical Drawing

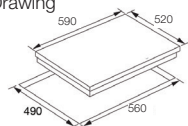

Ceramic Electric Hob with touch control 4 Zones

Dimension	Cat. No.
590 x 520 x 65 mm	538.06.221

•Cut out Dimension: 560 x 490 mm

Induction Hob



Technical Drawing

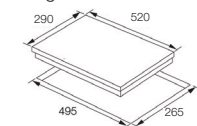

2 zone Induction Hob with Touch Control

Dimension	Cat. No.
290 x 520 x 68.5 mm	538.06.480

•Cut out Dimension: 268 x 495 mm

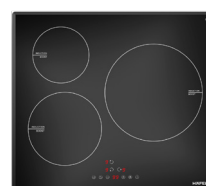

Technical Drawing

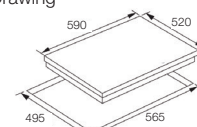

3 zone Induction Hob with Touch Control

Dimension	Cat. No.
590 x 520 x 68.5 mm	495.06.109

•Cut out Dimension: 565 x 495 mm

Cabinet Hood



Dual Motor

Description	Cat. No.
N3 ST.ST. 600 mm	539.82.102
N3 ST.ST. 900 mm	539.82.103
N3 White 600 mm	539.82.112
N3 ST.ST. 600 mm 1 motor	539.82.172

*2 pieces Round Carbon filter 500.30.982 not included

Telescopic Hood



Description	Cat. No.
SL1 600 mm	539.82.081

*2 pieces Round Carbon filter 500.30.982 included

Wall Mounted Stainless Steel with Glass



Description	Cat. No.
Lux 900 mm	500.30.323

*2 pieces Round Carbon filter 500.30.983 included

Wall Mounted Stainless Steel

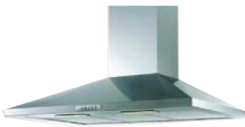

Description	Cat. No.
Lion 600 mm	500.30.312
Lion 900 mm	500.30.313

*2 pieces Round Carbon filter 500.30.983 included

Wall-Mounted, Chimney Hood Shark

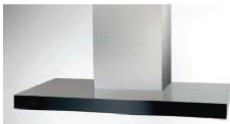

Finish / Length	Cat. No.
Stainless Steel, Black glass 900 mm	539.82.263

*2 pieces Round Carbon filter 500.30.982 included

Ceiling Mounted, Chimney Hood Shark

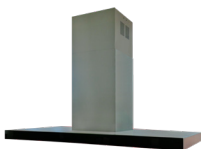

Finish / Length	Cat. No.
Stainless Steel, Black glass 900 mm	537.82.703

*2 pieces Round Carbon filter 500.30.982 included

Hoods Accessories
Carbon Filter



Description	Dimension	Cat. No.
Round	Ø 140 mm	532.87.955
	Ø 148 mm	500.30.983
	Ø 190 mm	500.30.982
Rectangular	248 x 92 mm	500.30.984

Freestanding Cooker:
Gas cooktop/ Gas oven



Description	Dimension	Cat. No.
4 multi-gas burner	500 x 600 x 850 mm	533.02.450
3 multi-gas burner + 1 hotplate		533.02.460
4 multi-gas burner	600 X 600 X 850 mm	533.02.470
3 multi-gas burner+ 1 hotplate		533.02.480

Electric Freestanding Cooker



4 Hotplates

Dimension	Cat. No.
600 x 600 x 850 mm	533.02.490



1 Hotplate and 3 Gas burners with smart timer

Dimensions	Cat. No.
600 x 600 x 850 mm	533.02.420



50 cm Freestanding Cooker, 3 Multi-gas burners with 1 Electric Hotplate and 52L Gas oven

Dimensions	Cat. No.
500 x 600 x 850 mm	533.02.380

Refrigerator



Dimensions	Cat. No.
910 x 655 x 1770 mm	534.14.070

Dishwasher Free-standing, Table-top



Dimensions	Cat. No.
550 x 514 x 438 mm	539.20.600

Front Pull-out Dish Basket
Basket with Softclose runner,
St.St. 304



Technical Drawing

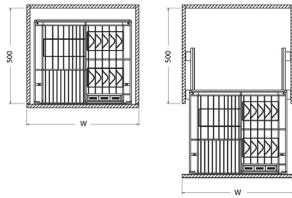

- Front pull-out dish basket (450 mm runner)

Cabinet width mm	Basket Dim. (WxDxH) mm	Cat. No.
600	537x465x195	549.03.154
800	737x465x195	549.03.155

Front Pull-out Basket
Basket with runner, St.St. 304



Technical Drawing

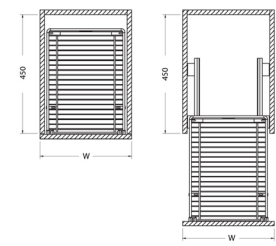

- Front pull-out basket (450 mm runner)

Cabinet width mm	Basket Dim. (WxDxH) mm	Cat. No.
400	315 x 465 x 148	549.03.141
450	365 x 465 x 148	549.03.142
500	415 x 465 x 148	549.03.143
600	515 x 465 x 148	549.03.144
800	715 x 465 x 148	549.03.145

Pull-out Dish Basket
Basket with Softclose runner,
St.St. 304



Technical Drawing

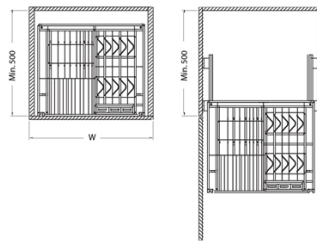

- Pull-out dish basket (450 mm runner)

Cabinet width mm	Basket Dim. (WxDxH) mm	Cat. No.
600	510 x 473 x 148	549.03.254

Magic Corner, St.St.304
Softclose



Technical Drawing

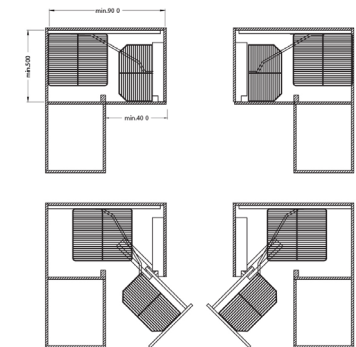

Cabinet width mm	Cat. No.
900 mm (Right Open)	548.21.002
900 mm (Left Open)	548.21.012

Pull-out Basket
Basket with Softclose runner,
St.St. 304



Technical Drawing

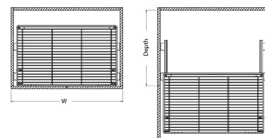

- Pull-out basket (450 mm runner)

Cabinet width mm	Basket Dim. (WxDxH) mm	Cat. No.
400	315 x 465 x 148	549.03.131
450	365 x 465 x 148	549.03.132
500	415 x 465 x 148	549.03.133
600	515 x 465 x 148	549.03.134
800	715 x 465 x 148	549.03.135



Multi-Functional Basket
St.St.304, Softclose



Technical Drawing

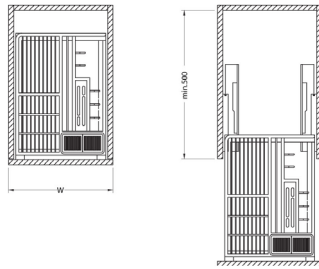

- Front pull-out basket (450 mm runner)

Cabinet width mm	Basket Dim. (WxDxH) mm	Cat. No.
300	240 x 455 x 480	549.34.053
400	340 x 455 x 480	549.34.055

Base Unit
Two Layers Basket, St.St.304
Softclose



Technical Drawing

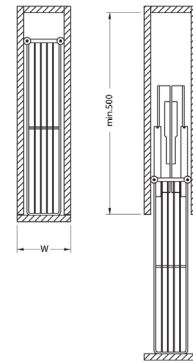

Cabinet width mm	Cat. No.
150 MM	549.34.022

Pull out Tall Unit Softclose
5 Layers Basket, St.St.304



Technical Drawing

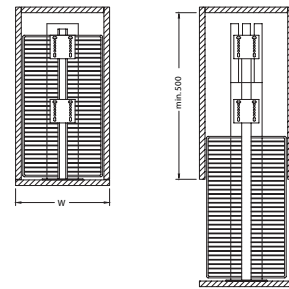

Cabinet width mm	Cat. No.
300 MM	548.93.113
400 MM	548.93.133

Side Mounted Base Unit,
Pull-out-Left St.St.304



Technical Drawing

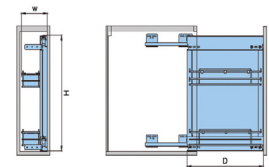

Cabinet width mm	Basket Dim. (WxDxH) mm	Cat. No.
200	158x465x580	549.32.171

Swivel Pull out, Softclose
6 Layers basket, SS304 Basket
Powder Coated Frame



Technical Drawing

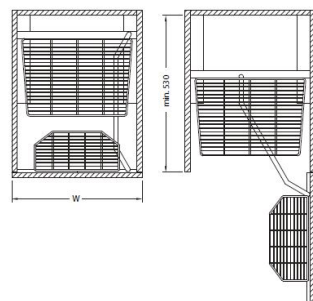

Opening 90°

Cabinet width mm	Cat. No.
450 MM	548.91.083

Half Coursel Wirebasket
St.St. 304



Technical Drawing

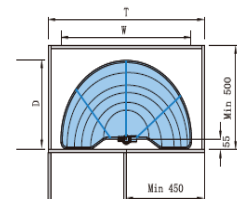

Cabinet width mm	Basket Dim. (WxDxH) mm	Cat. No.
600	694 x 595-895	548.24.101

H-style Dish Rack,



Material	Cat. No.
Stainless steel	495.34.160

Hanging Plate Rack

Technical Drawing

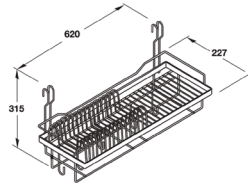

Material	Cat. No.
Stainless steel 304	522.59.110

- Supplied with:
- 1pc. Plate hang rack
 - 2pcs. Transparent Trays
 - 8 Rubber covers
 - 1pc Tube 600mm
 - 1 Set tube holder

Multi-purpose Hanging Rack

Material	Cat. No.
Stainless steel 304	522.59.100



- Supplied with:
- 2pcs Multi-purpose rack
 - 8 Rubber cover
 - 1pc Tube (1200mm)
 - 1 set tube holder (left,middle,right)



Plate rack, 1-layer

Technical Drawing

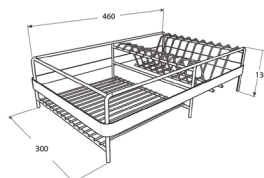

Material	Cat. No.
Stainless steel 304	522.47.201

- Supplied with:
- 1 pc. plate rack
 - 1 pc. drip o tray
 - 1 pc. cutlery holder
 - 6 pcs. rubbers

Removable plate rack, 2-layers



Technical Drawing

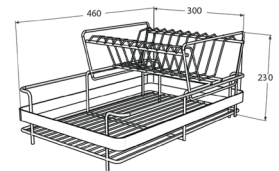

Material	Cat. No.
Stainless steel 304	522.47.211

- Supplied with:
- 1 pc. removable plate rack
 - 1 pc. drip o tray
 - 1 pc. cutlery holder
 - 6 pcs. rubber

Plate rack, 2-layers



Technical Drawing

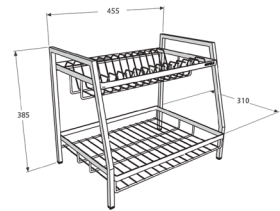

Material	Cat. No.
Stainless steel 304	495.34.193

- Supplied with:
- 1 pc. plate rack (2layers)
 - 1 pc. cutlery tray
 - 1 pc. drip o tray
 - 4 pcs. cover rubber

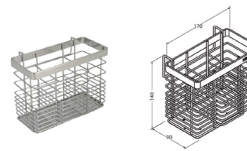

Wine Glass Holder



Material	Cat. No.
Stainless steel 304	541.89.151

Supplied with: 1pc of glass holder



Accessories
S-Hook
Stainless steel 201



Dimension	Cat. No.
40 x 5 x 72 mm	522.59.190

Single towel bar

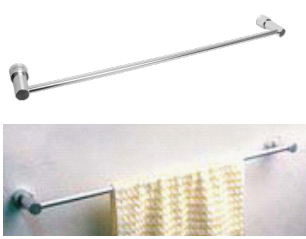

Technical Drawing



Dimension	Cat. No.
611 x 75 mm	580.80.310

Chrome Plated Finish



Dimension	Cat. No.
70.8 x 50.25 x 44.5 mm	980.83.362

Technical Drawing

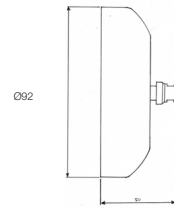

Dimension	Cat. No.
92 x 50 mm	980.64.352

Double hook

Technical Drawing

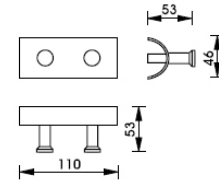

Dimension	Cat. No.
110 x 53 x 46 mm	980.64.162

Technical Drawing

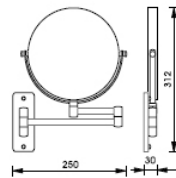

Dimension	Cat. No.
312 x 30 x 250 mm	980.64.512



Dimension	Cat. No.
75.5 x 648.5 x 48 mm	980.83.212



Dimension	Cat. No.
48 x 65.5 mm	980.83.232

Stainless Steel



Dimension	Cat. No.
58 x 39 x 61 mm	499.98.314

Technical Drawing

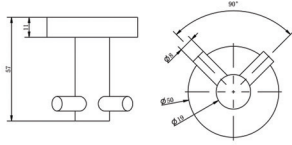

Dimension	Cat. No.
600 x 111 x 211 mm	499.98.315

Technical Drawing

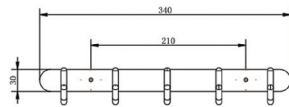

Dimension	Cat. No.
220 x 131 x 60 mm	499.98.318

Technical Drawing

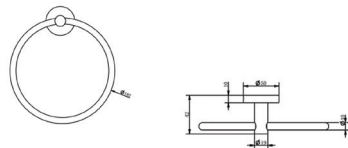

Dimension	Cat. No.
220 x 131 x 60 mm	499.98.313

Technical Drawing

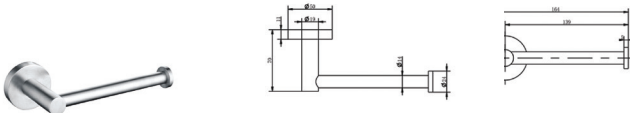

Dimension	Cat. No.
171 x 32 x 91 mm	499.98.312

Technical Drawing



Dimension	Cat. No.
58 x 39 x 61 mm	499.98.319

Dimension	Cat. No.
614 x 32 x 80 mm	499.98.316



Stainless Steel



Technical Drawing

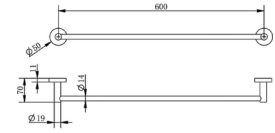

Dimension	Cat. No.
614 x 32 x 80 mm	499.98.310

Technical Drawing

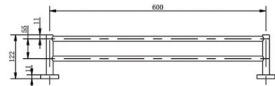

Dimension	Cat. No.
614 x 32 x 120 mm	499.98.311

Technical Drawing

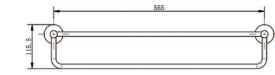

Dimension	Cat. No.
614 x 32 x 120 mm	499.98.317

Dimension	Cat. No.
614 x 32 x 120 mm	499.98.317

Technical Drawing



Dimension	Cat. No.
600 x 111 x 211 mm	499.98.320

Technical Drawing

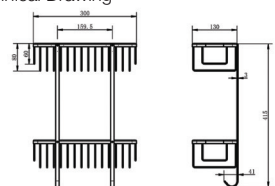

Dimension	Cat. No.
171 x 32 x 91 mm	499.98.321

Technical Drawing

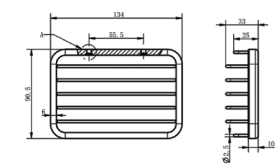

Dimension	Cat. No.
171 x 32 x 91 mm	499.98.322

Brass Chrome plated
polished Grab Rail



Technical Drawing



A = 368mm, B = 268mm
(400mmx300mm)

Dimension	Cat. No.
368 x 268 mm	499.95.200

Technical Drawing

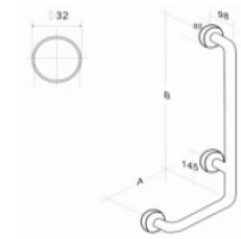

A = 418mm, B = 768mm
(450mmx800mm)

Dimension	Cat. No.
418 x 768 mm	499.95.203

Technical Drawing

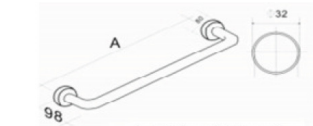

A = 568mm(600mm)

Dimension	Cat. No.
600 mm	499.95.202

Technical Drawing

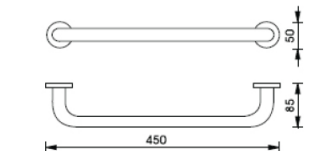

Dimension	Cat. No.
450 x 50 x 85 mm	980.64.432

Taps and Mixer



2-way Faucet



Material / Finish	Cat. No.
Stainless Steel 304	495.61.182

Material/Finish	Cat. No.
Brass chrome plated polished	485.60.213

Material / Finish	Cat. No.
Stainless Steel 304	495.61.183

1/2 in x 1/2 in

Description	Cat. No.
Stainless steel 201 / 35 cm	566.08.980
Stainless steel 201 / 40 cm	566.08.981
Stainless steel 201 / 45 cm	566.08.982
Stainless steel 201 / 50 cm	566.08.983
Stainless steel 201 / 60 cm	566.08.984



Description	Cat. No.
Stainless steel 304	485.61.216

Description	Cat. No.
Stainless steel304	485.61.215

Handheld Shower



- Hand shower Ø75mm
- Version: 3-functions hand shower
- Shower hose: 1,500 mm with conical swivel 360°
- Flow limiter: 9.5 L/min
- Adjustable shower holder
- Chrome shiny hose easy to clean

Finish	Cat. No.
Chrome polished	495.60.655

Technical Drawing



- Hand shower Ø80mm
- Version: 1-functions hand shower
- Shower hose: 1,500 mm with conical swivel 360°
- Flow limiter: 9.5 L/min
- Adjustable shower holder
- Chrome shiny hose easy to clean

Finish	Cat. No.
Chrome polished	495.60.656

Technical Drawing

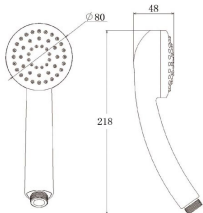

- Hand shower Ø100mm
- Version: 1-functions hand shower
- Shower hose: 1,500 mm with conical swivel 360°
- Flow limiter: 9.5 L/min
- Adjustable shower holder
- Chrome shiny hose easy to clean

Finish	Cat. No.
Chrome polished	495.60.657

Technical Drawing

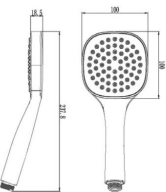

- Hand shower Ø100mm
- Version: 3-functions hand shower
- Shower hose: 1,500 mm with conical swivel 360°
- Flow limiter: 9.5 L/min
- Adjustable shower holder
- Chrome shiny hose easy to clean

Finish	Cat. No.
Chrome polished	495.60.658

Technical Drawing

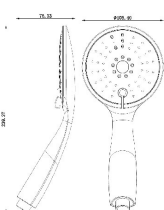

Shower sliding bars and column sets

Shower Column



Technical Drawing

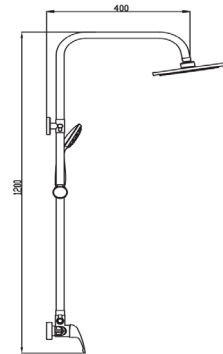

- Shower column, 8inch shower head, 20mm S.S304 shower, 22mm S.S304 rail, brass diverter, brass mixer, 3-way handshower, 1.5m s.s double interlock shower hose, chrome plated
- Flow rate of hand and overhead shower 2.5 GPM
- Water pressure maximum at 0.56 Mpa
- Air pressure measured at 0.6 Mpa

Finish	Cat. No.
Chrome polished	495.60.077

Technical Drawing

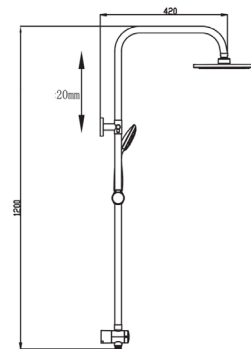

- Shower column, 8inch shower head, 20mm S.S304 shower, 20mm S.S304 rail, brass diverter, brass mixer, 3-way handshower, 1.5m s.s double interlock shower hose, chrome plated
- Flow rate of hand and overhead shower 2.5 GPM
- Water pressure maximum at 0.56 Mpa
- Air pressure measured at 0.6 Mpa

Finish	Cat. No.
Chrome polished	495.60.078

Technical Drawing

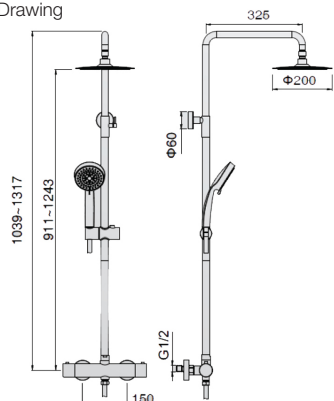

- Flow-rate of showers no greater than 9L, bath mixer Minimum a 6.5L under 0.1 MPa
- Diameter 200 mm stainless steel shower head
- Three functions ABS hand shower
- 1.5 meter 304 stainless steel shower hose
- 35mm ceramic cartridge
- 70,000 cycles
- Material: Stainless steel 304

Finish	Cat. No.
304 Stainless Steel	495.60.001

Handheld Shower,
Sliding Bar



Technical Drawing

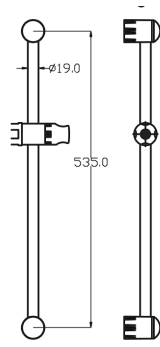

Features

- 19mm diameter, 600mm length s.s. chrome rail with sliding holder
- 90mm plate handheld shower
- 1.5m s.s. double interlock shower hose
- with transparent soap dish
- flow rate at max. 2.5 GPM under 80 PSI

Description	Cat. No.
Chrome polished	495.60.060

Technical Drawing

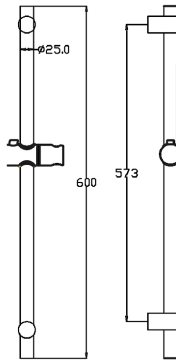

Features

- 25mm diameter, 600mm length s.s. chrome rail with sliding holder
- 80mm plate handheld shower
- 1.5m s.s. double interlock shower hose
- with transparent soap dish
- flow rate at max. 2.5 GPM under 80 PSI

Description	Cat. No.
Chrome polished	495.60.061

Technical Drawing

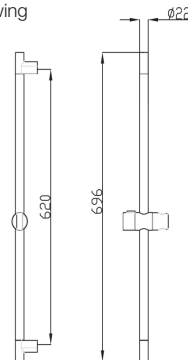

Features

- 22mm diameter, 600mm length s.s. chrome rail with sliding holder
- 85mm plate handheld shower
- 1.5m s.s. double interlock shower hose
- with transparent soap dish
- flow rate at max. 2.5 GPM under 80 PSI

Description	Cat. No.
Chrome polished	495.60.062

Shower Heads



Description	Cat. No.
Fixed shower	485.60.312



Description	Cat. No.
Shower Head 160 mm, Chrome polished	495.60.306



Description	Cat. No.
Shower Head 200 mm, Chrome polished	495.60.307



Bidet spray set



Finish	Cat. No.
Chrome plated polished	589.34.044



Finish	Cat. No.
Stainless Steel	485.95.014



Finish	Cat. No.
Chrome Plated	485.95.008



Finish	Cat. No.
Satin Nickel Stainless Steel	485.95.053



Material / Finish	Cat. No.
Plastic / Black matt	495.95.100



Material / Finish	Cat. No.
Stainless steel 304 / Black matt	495.95.102

Angle valve



Material/Finish	Cat. No.
Brass chrome plated polished	589.25.906



Material/Finish	Cat. No.
Brass chrome plated polished	589.25.907



Material / Finish	Cat. No.
Brass chrome plated polished	589.25.911



Material / Finish	Cat. No.
Brass chrome plated polished	589.25.921



Material/Finish	Cat. No.
Brass chrome plated polished	589.25.923



Material/Finish	Cat. No.
Brass chrome plated polished	566.08.990



Material/Finish	Cat. No.
Stainless steel 304	495.60.817



Material/Finish	Cat. No.
Stainless steel 304	495.60.816

1/2 Two-way Angle Valve



Material/Finish	Cat. No.
Stainless steel 304 (Black matt)	495.60.818

1/2 Angle Valve



Material/Finish	Cat. No.
Stainless steel 304 (Black matt)	495.60.819

Concealed Valve



Description	Cat. No.
Polished Chrome	485.61.033

PROMOTIONAL DISPLAY MODULES



 KITCHEN APPLIANCE
MODULE



 KITCHEN SINK
MODULE



 WIREBASKETS
MODULE

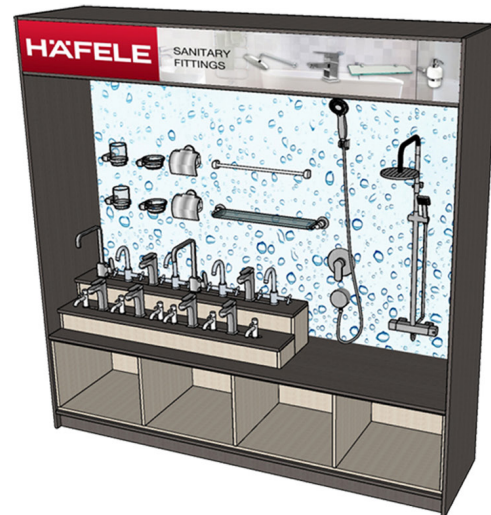

 SANITARY FITTINGS
MODULE



 SLIDING DOOR FITTINGS &
LOCKSET MODULE

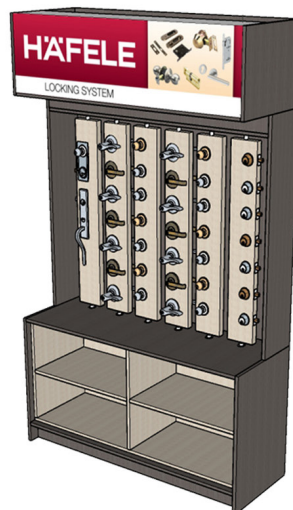

 LOCKSET MODULE

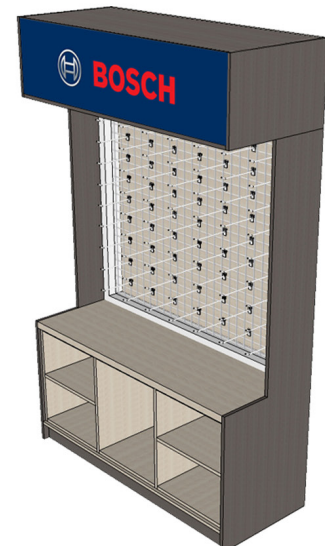

 BOSCH POWER
TOOLS MODULE

name: _____

project: _____

date: _____

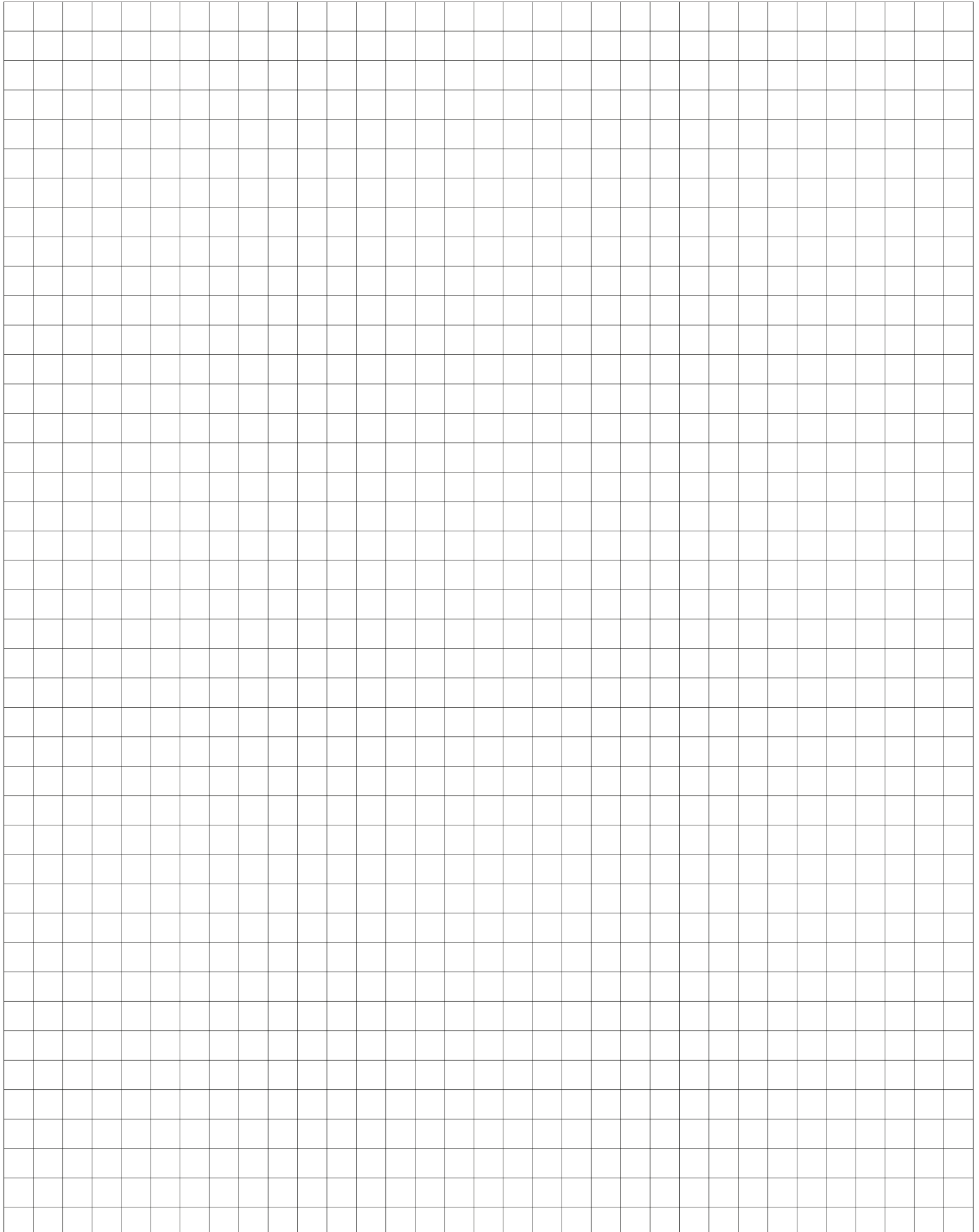

Imprint:

This catalog is only intended for the use of the recipient.
The contents in all aspects remains the property of Häfele.
Reproductions of this catalog in whole or in part, the copying or imitation of any illustrations, and the imitation of the layout are strictly prohibited. The technical descriptions in this catalog, also those with the photographs and drawings, are not binding.

We reserve the right to make design improvements.
All dimensions are in mm, unless stated otherwise.

We bear no liability for any misprints or other errors that might occur in the production of this catalog.

All deliveries are made pursuant to Häfele's sales conditions.



HÄFELE

Copyright by Häfele Philippines Inc.
All Rights Reserved 2022
Printed in the Philippines