









LED 2040

833.72.370 833.72.372
833.72.371 833.72.333

	K	W	T_A	 mm	 mm	
833.72.370	2700 K	1.5 W	-20 °C – +35 °C -4 °F – +95 °F	Ø 38.5 x 15	≥ Ø 48.5 x 25	<div style="border: 1px solid black; padding: 5px; display: inline-block;"> Loox 12 V </div>
833.72.371	3000 K					
833.72.372	4000 K					
833.72.333	5000 K					

732.26.383



A

+

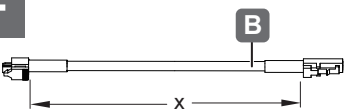

x	
500	833.72.880
1000	833.72.881
2000	833.72.882

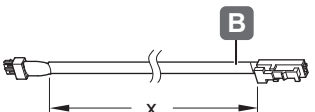

x	
500	833.72.128
1000	833.72.129
2000	833.72.123

+

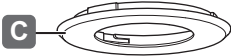

C

833.72.145	<input type="checkbox"/>
833.72.184	<input type="checkbox"/>
833.72.186	<input type="checkbox"/>
833.72.187	<input type="checkbox"/>



D

833.72.146	<input type="checkbox"/>
833.72.188	<input type="checkbox"/>
833.72.190	<input type="checkbox"/>
833.72.191	<input type="checkbox"/>

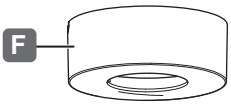

F



E 2x

833.72.143	<input type="checkbox"/>
833.72.176	<input type="checkbox"/>
833.72.178	<input type="checkbox"/>
833.72.179	<input type="checkbox"/>

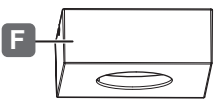

F



E 2x

833.72.144	<input type="checkbox"/>
833.72.180	<input type="checkbox"/>
833.72.182	<input type="checkbox"/>
833.72.183	<input type="checkbox"/>

HDE 04/2017

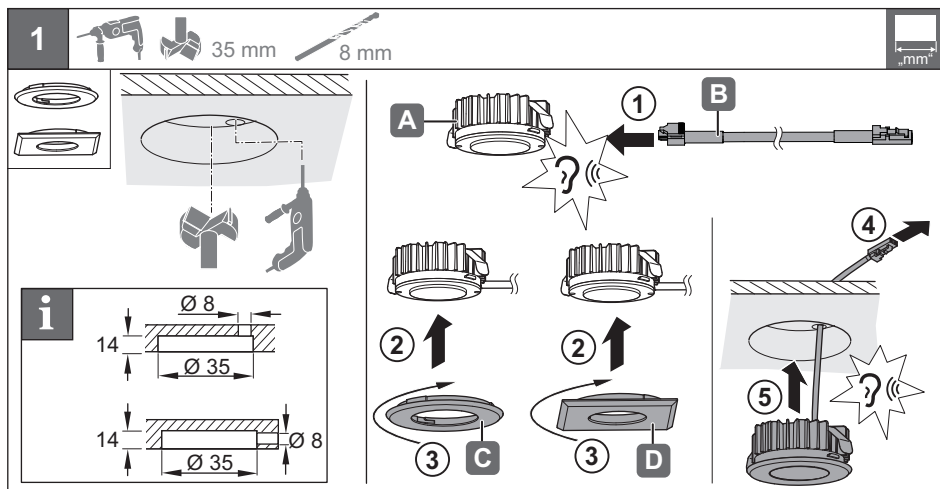
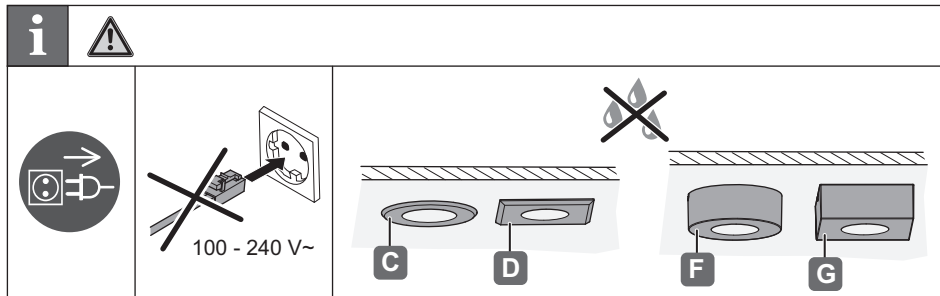

732.26.383

HDE 04/2017

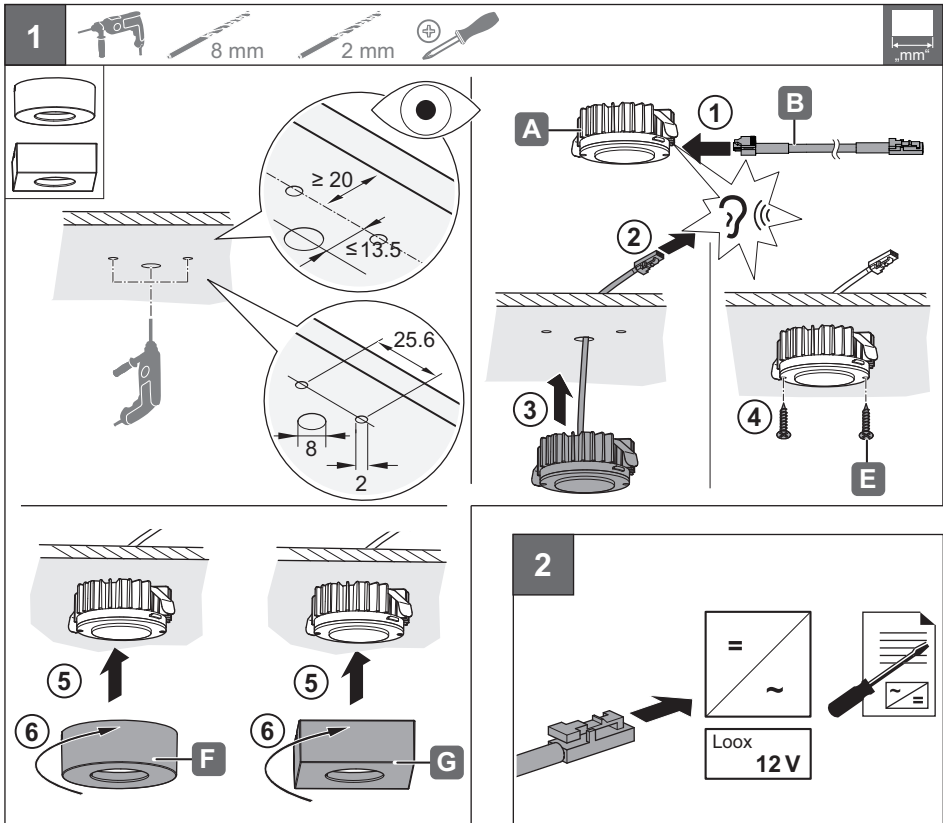

732.26.383

HDE 04/2017